

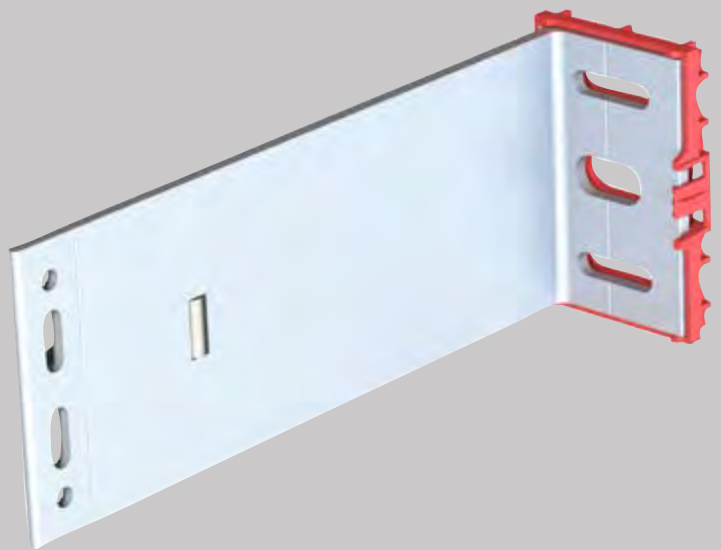

MFT-FOX VI-1L- BULLONI

**Sistema di Facciata Ventilata
Hilti**



CONTENUTI

Pannelli	3
Applicazione e Descrizione	4
Disegni di Sistema	5-15
Tipologie di Staffe	
MFT-FOX VI Small	16
MFT-FOX VI Medium	17
MFT-FOX VI Large	18
Capacità di Regolazione	19
Prodotti	20-21

MFT-FOX VI-1L-bulloni



Metal



Composite





APPLICAZIONE E DESCRIZIONE

MFT-FOX VI-1L-bulloni

Il sistema consiste in mensole e profili in alluminio ed è progettato specificamente per sottostrutture verticali in facciate ventilate composte da cassette come materiale di rivestimento.

Le mensole sono fornite con elementi isolanti preassemblati e, secondo il metodo di installazione al materiale base (tasselli, viti o fissaggio diretto), con diverse geometrie dei fori nella piastra base (le geometrie dei fori disponibili sono illustrate nel catalogo o nelle pagine seguenti).

Le mensole sono progettate con punti sia fissi che flessibili, per consentire l'espansione termica del profilo. Il punto fisso assorbe il peso dei pannelli e della sottostruttura e i carichi del vento proporzionali, mentre il punto flessibile assorbe solo i carichi del vento proporzionali.

I profili verticali sono connessi alle mensole con viti appositamente studiate per punti fissi e flessibili. I punti fissi non consentono il movimento verticale dei profili contro le mensole, mentre i punti flessibili consentono uno scorrimento, praticamente senza attrito, dei profili contro le mensole. Il punto flessibile consente di evitare l'aggiunta di carichi alla sottostruttura a seguito delle forze di espansione del profilo.

L'adattamento dei profili rispetto alle mensole è agevolato da un elemento ausiliario. Tale elemento ausiliario tiene il profilo in posizione mentre questo viene fissato con viti, in modo da rendere più rapido il processo di connessione alla mensola. Con questo sistema, è possibile compensare perfettamente una tolleranza dimensionale delle pareti fino a 40 mm. Le mensole sono disponibili in 3 diverse misure (grande, media e piccola), da 40 mm a 300 mm, incluso un elemento isolante di 6 mm, con incrementi di 20 mm. L'elemento isolante separa la sottostruttura dal materiale base, per ridurre il ponte termico.

I profili verticali sono studiati specificamente per materiale di rivestimento composto da cassette. Il bullone in alluminio supporta la cassetta e trasferisce il carico alla sottostruttura. Può essere montato in qualsiasi momento e non è necessario preassemblarlo nel profilo. Il bullone è fissato con due morsetti al profilo, con posizione regolabile non fissata da griglie preimpostate.

Vantaggi

- Design flessibile con punti fissi e flessibili
- Tre diverse misure: grande, media e piccola
- Adattamento della mensola rispetto al profilo fino a 40 mm
- Le mensole possono essere montate con diversi metodi: tasselli, viti o fissaggio diretto
- Un elemento isolante di 6 mm separa la sottostruttura dal materiale base, per ridurre il ponte termico
- Le sottostrutture possono essere dimensionate mediante il software PROFIS Facade, per generare soluzioni tecnicamente accettabili e ottimizzate dal punto di vista economico
- Possono essere utilizzate con i materiali di rivestimento a cassetta di uso più comune

DISEGNI DI SISTEMA

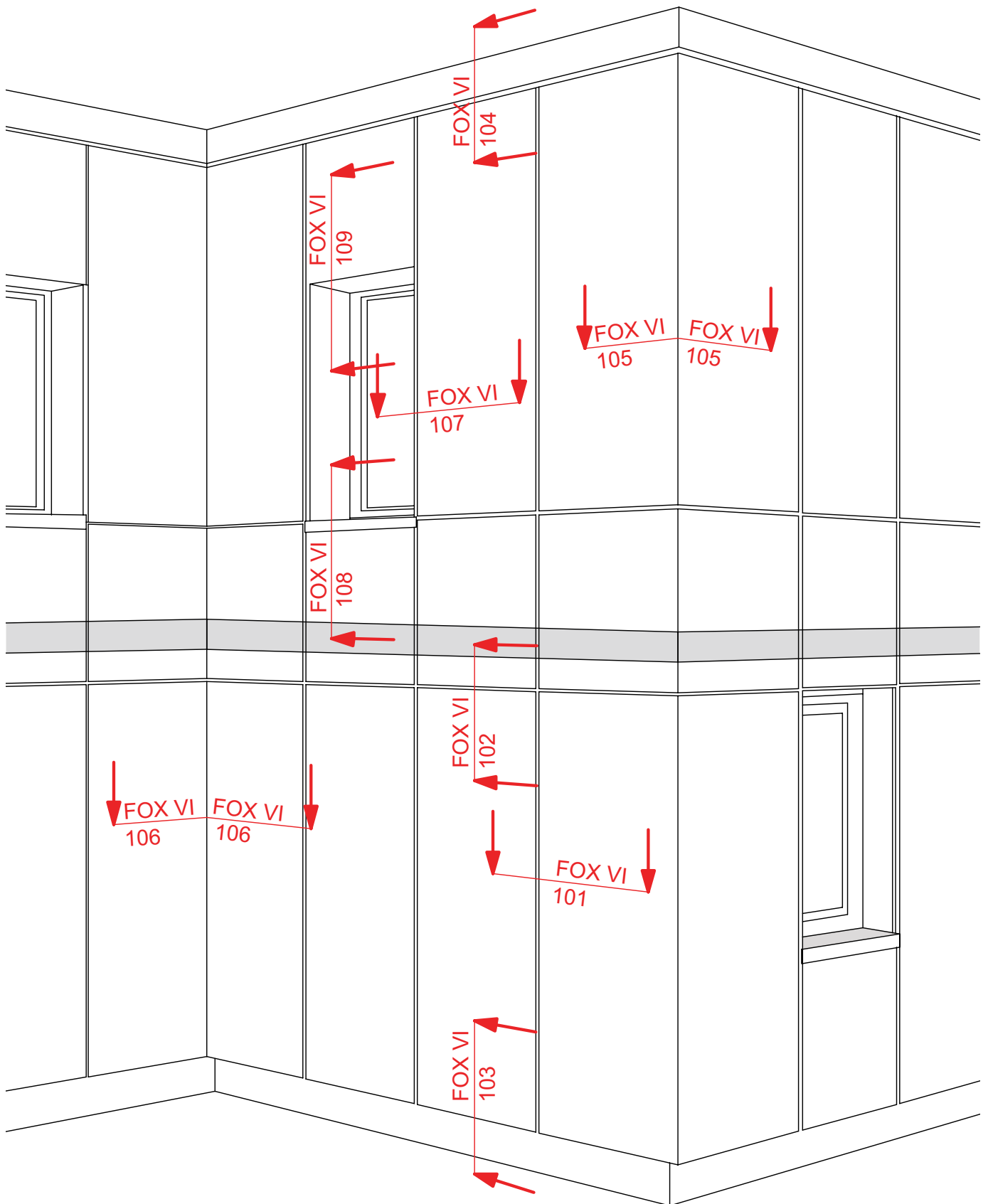

MFT-FOX VI 101

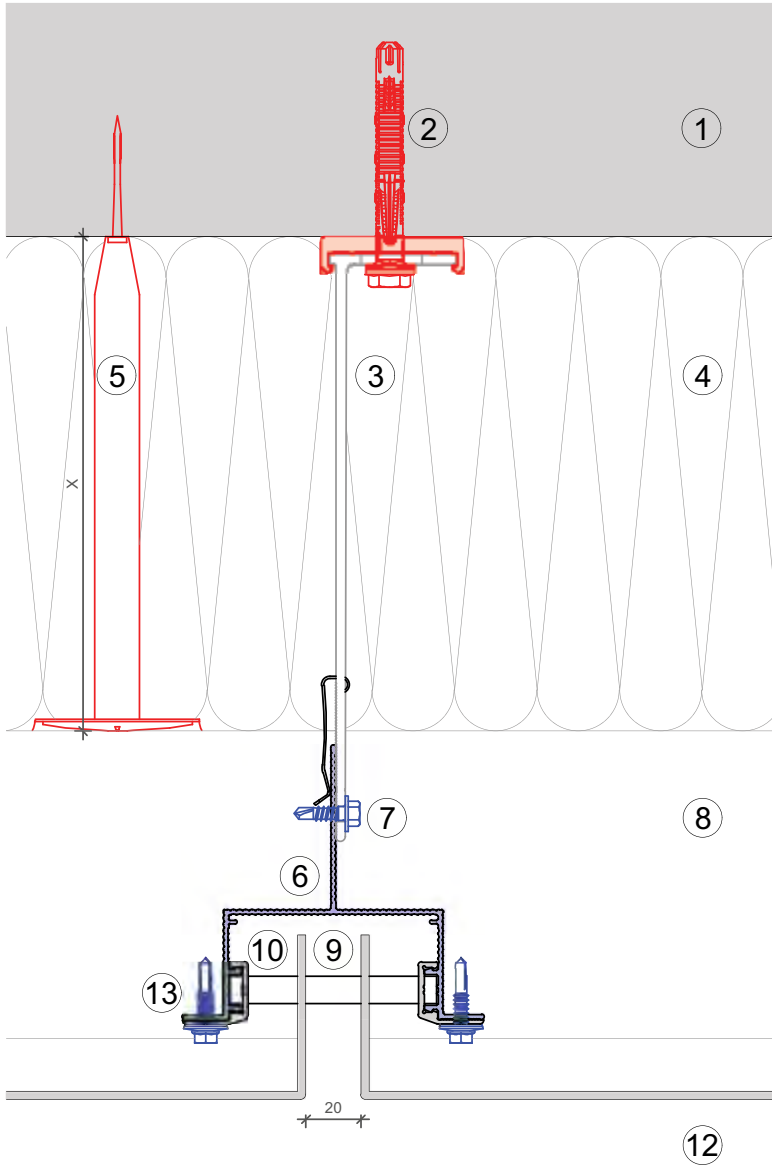

Legend:

- ① Base material
- ② Anchor acc. to static
- ③ Bracket and isolator MFT-FOX VI
- ④ Insulation
- ⑤ Fixing insulation
- ⑥ Profile MFT-CP T
- ⑦ Self drilling screw
- ⑧ Ventilation gap
- ⑨ Aluminum-bolt MFT-C BO
- ⑩ Clip MFT-C
- ⑬ Cladding

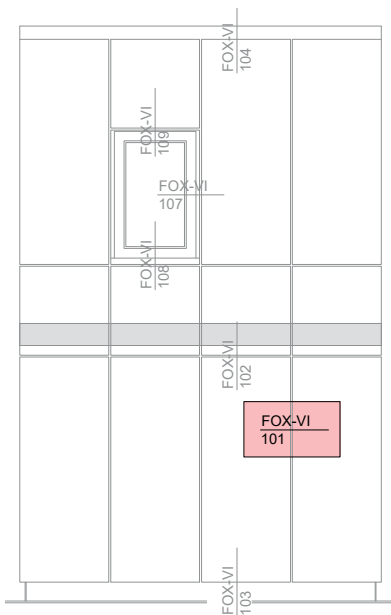

MFT-FOX VI 102

Legend:

- ① Base material
- ② Anchor acc. to static
- ③ Bracket and isolator MFT-FOX VI
- ④ Insulation
- ⑤ Fixing insulation
- ⑥ Profile MFT-CP T
- ⑦ Self drilling screw
- ⑧ Ventilation gap
- ⑨ Aluminum-bolt MFT-C BO
- ⑩ Clip MFT-C
- ⑪ Fixing cladding
- ⑫ Cladding

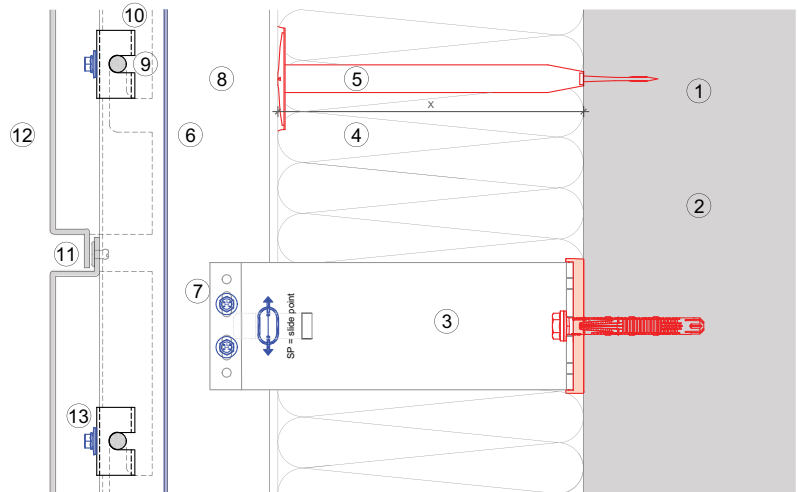

Vertical section-fixed point

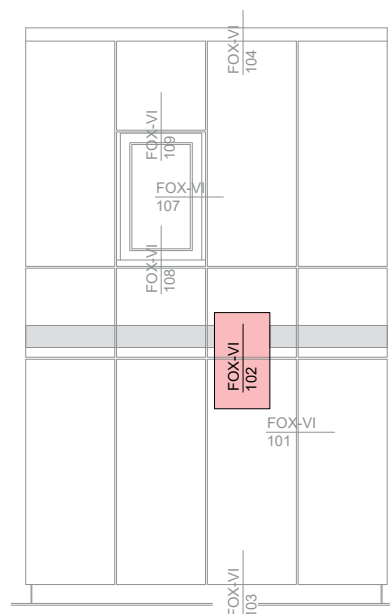
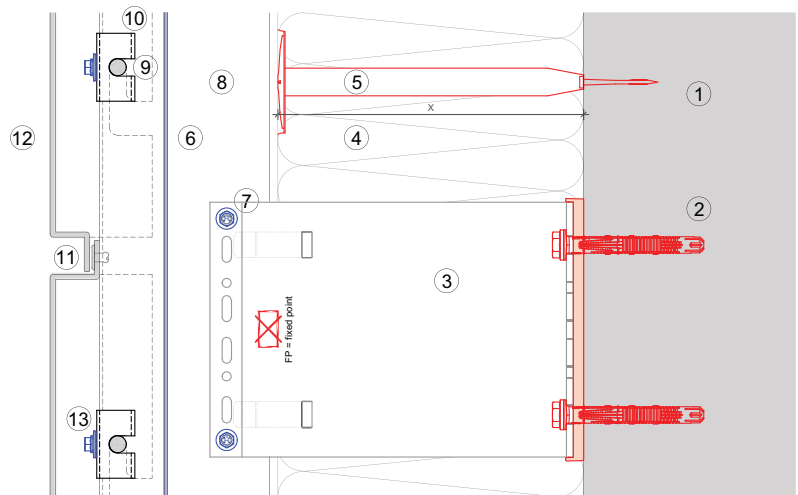

MFT-FOX VI 103

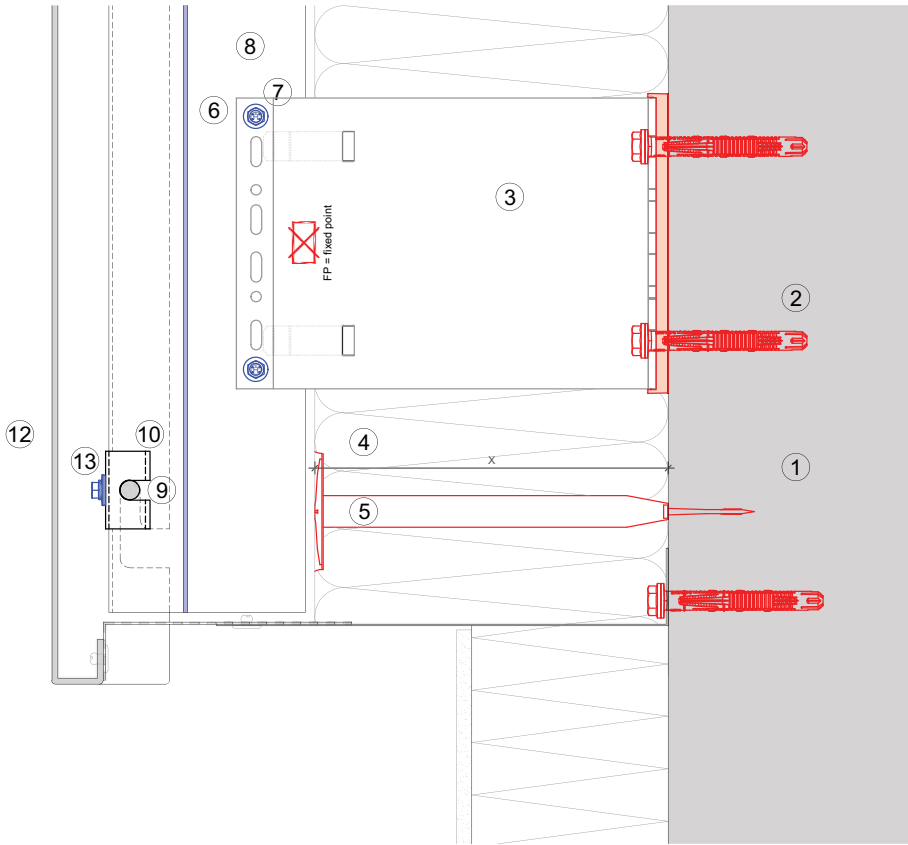

Legend:

- ① Base material
- ② Anchor acc. to static
- ③ Bracket and isolator MFT-FOX VI
- ④ Insulation
- ⑤ Fixing insulation
- ⑥ Profile MFT-CP T
- ⑦ Self drilling screw
- ⑧ Ventilation gap
- ⑨ Aluminum-bolt MFT-C BO
- ⑩ Clip MFT-C
- ⑪ Cladding
- ⑫ Cladding

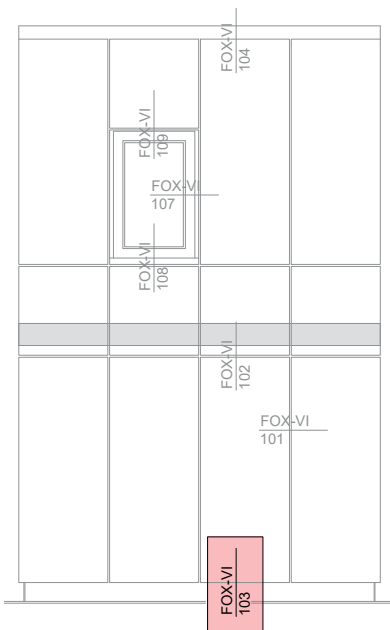

MFT-FOX VI 104

Legend:

- ① Base material
- ② Anchor acc. to static
- ③ Bracket and isolator MFT-FOX VI
- ④ Insulation
- ⑤ Fixing insulation
- ⑥ Profile MFT-CP T
- ⑦ Self drilling screw
- ⑧ Ventilation gap
- ⑨ Aluminum-bolt MFT-C BO
- ⑩ Clip MFT-C
- ⑪ Fixing cladding
- ⑫ Cladding

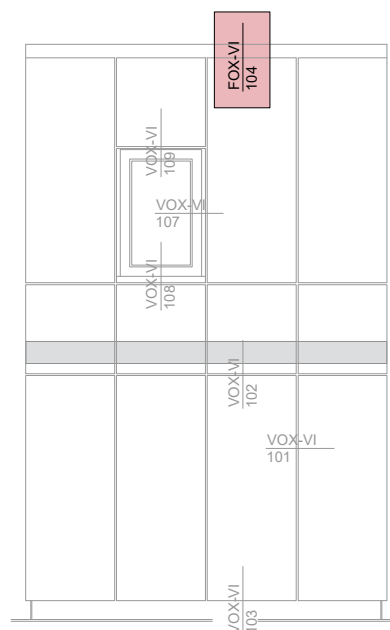
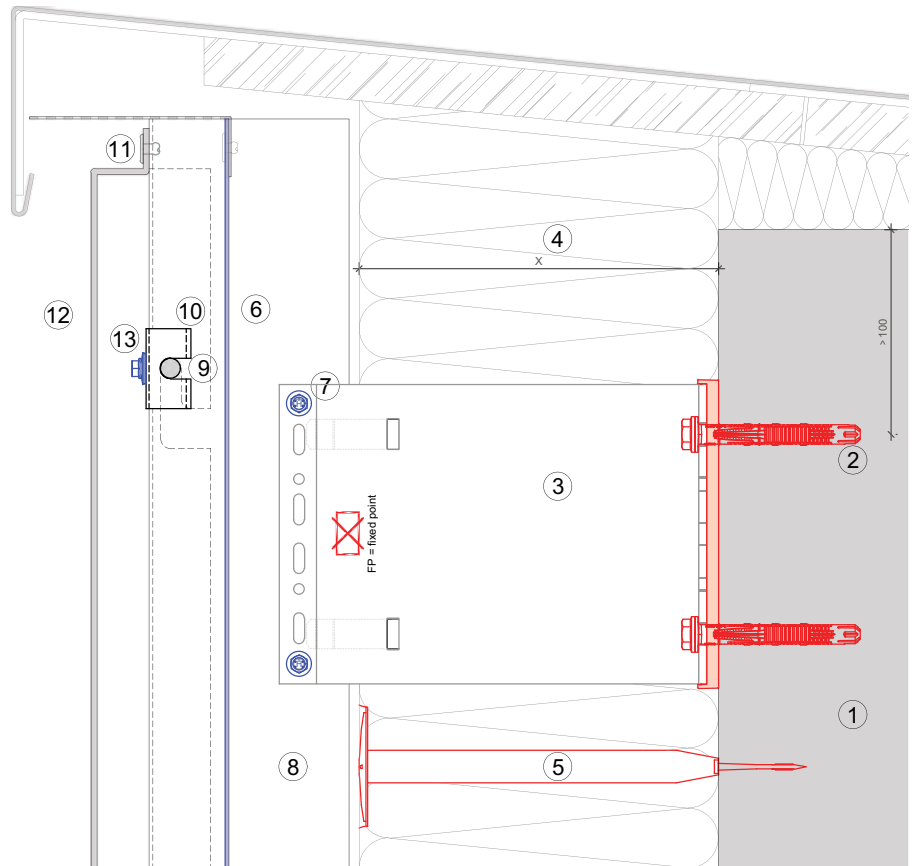

MFT-FOX VI 105

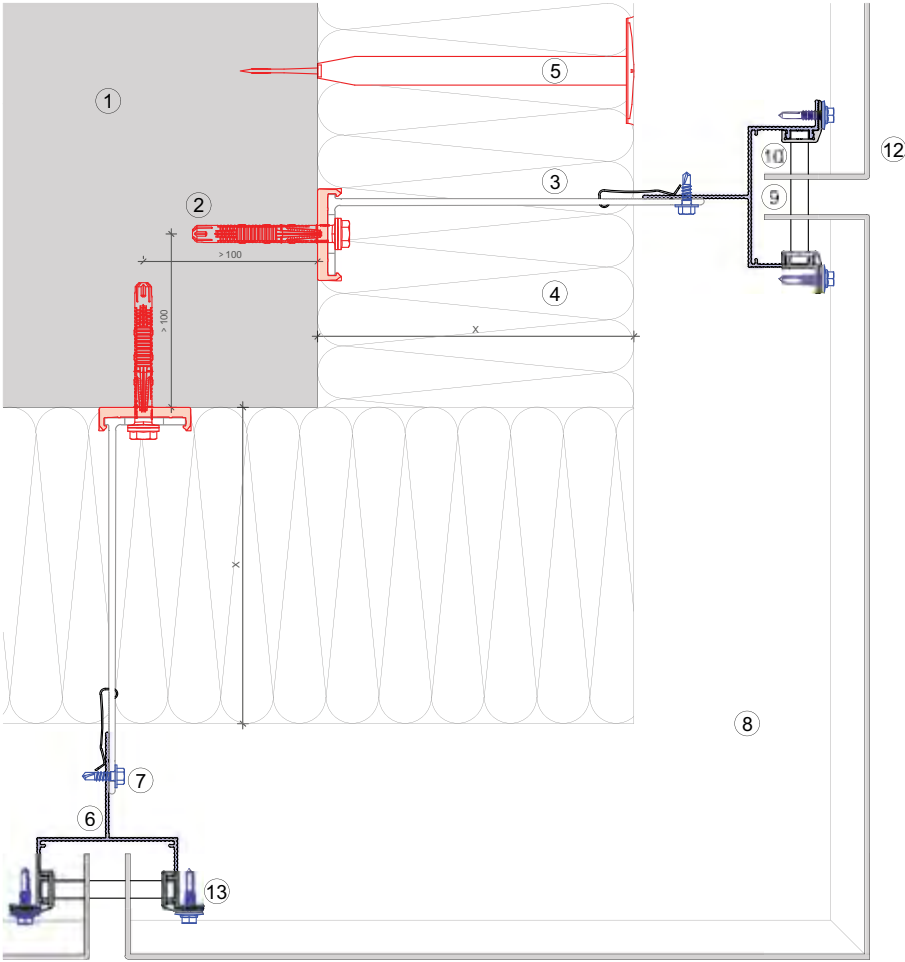

Legend:

- ① Base material
- ② Anchor acc. to static
- ③ Bracket and isolator MFT-FOX VI
- ④ Insulation
- ⑤ Fixing insulation
- ⑥ Profile MFT-CP T
- ⑦ Self drilling screw
- ⑧ Ventilation gap
- ⑨ Aluminum-bolt MFT-C BO
- ⑩ Clip MFT-C
- ⑫ Cladding

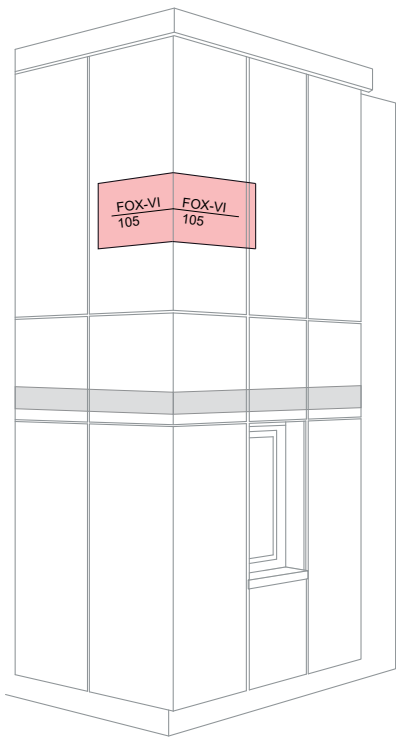

MFT-FOX VI 106

Legend:

- ① Base material
- ② Anchor acc. to static
- ③ Bracket and isolator MFT-FOX VI
- ④ Insulation
- ⑤ Fixing insulation
- ⑥ Profile MFT-CP T
- ⑦ Self drilling screw
- ⑧ Ventilation gap
- ⑨ Aluminum-bolt MFT-C BO
- ⑩ Clip MFT-C
- ⑫ Cladding

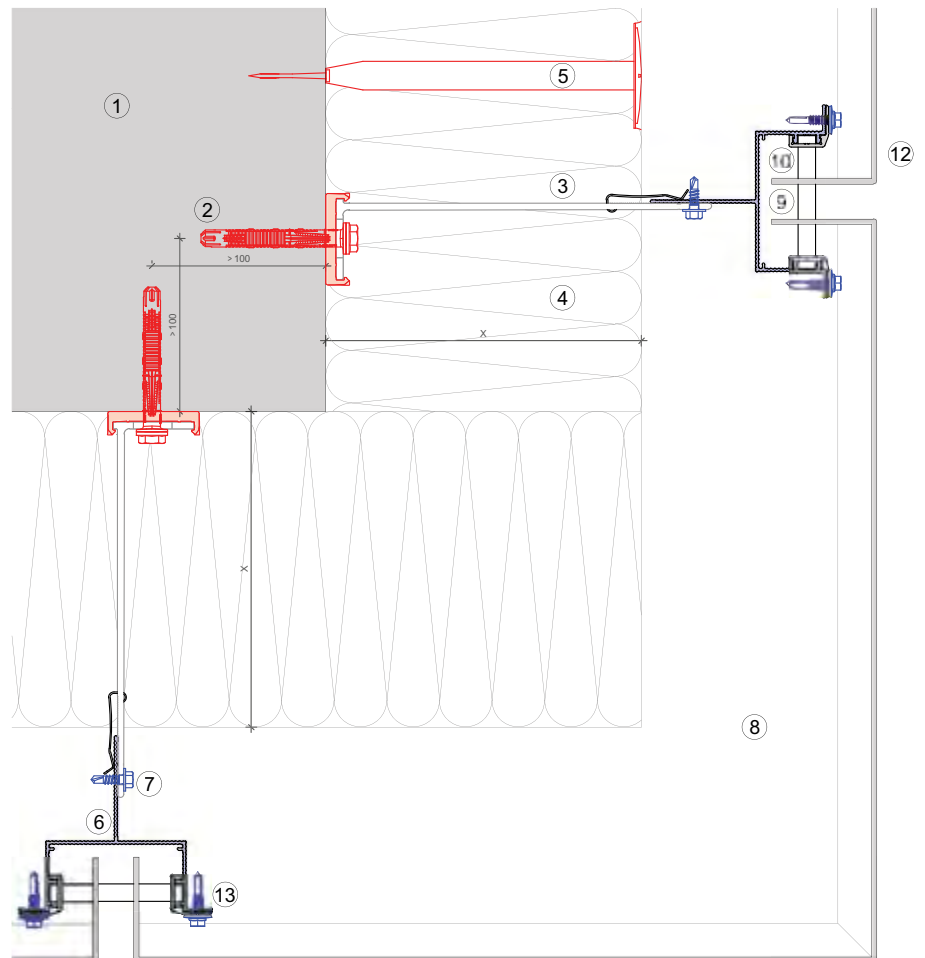

MFT-FOX VI 107

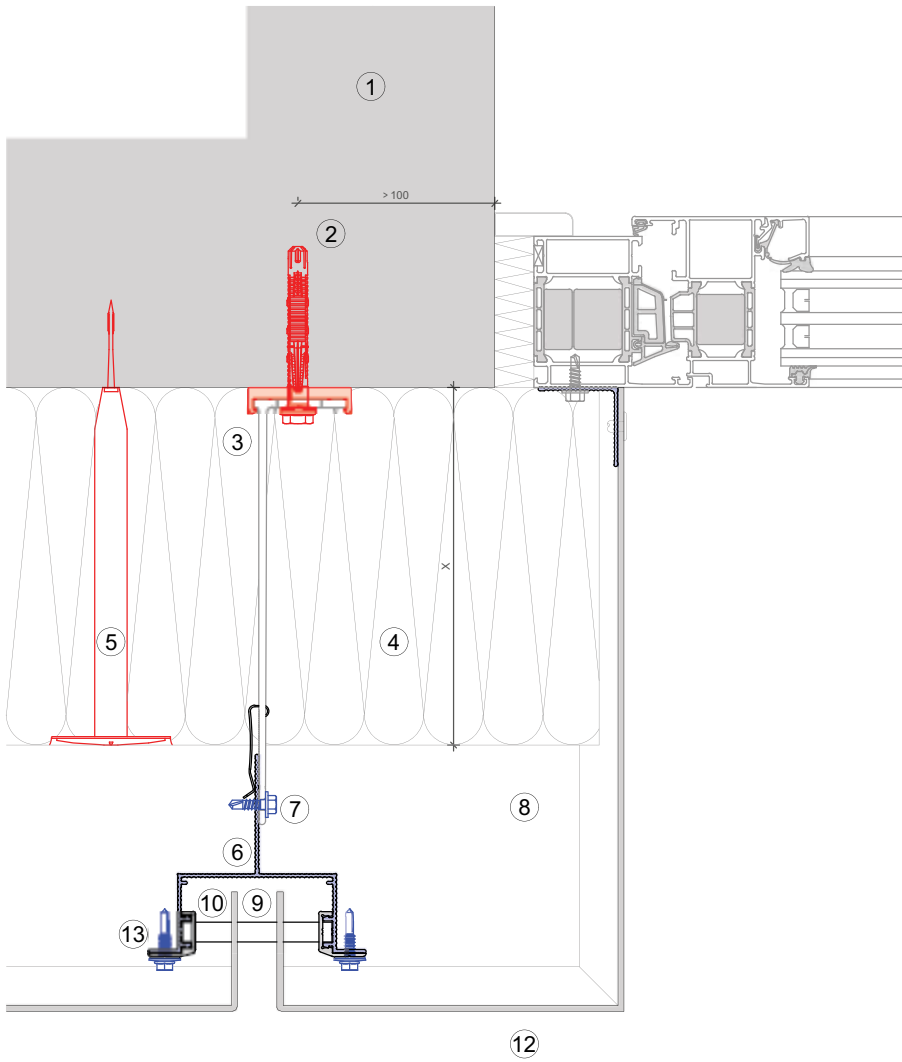

Legend:

- ① Base material
- ② Anchor acc. to static
- ③ Bracket and isolator MFT-FOX VI
- ④ Insulation
- ⑤ Fixing insulation
- ⑥ Profile MFT-CP T
- ⑦ Self drilling screw
- ⑧ Ventilation gap
- ⑨ Aluminum-bolt MFT-C BO
- ⑩ Clip MFT-C
- ⑫ Cladding

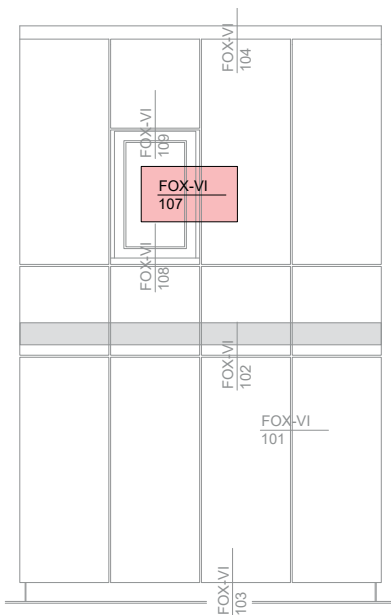

MFT-FOX VI 108

Legend:

- ① Base material
- ② Anchor acc. to static
- ③ Bracket and isolator MFT-FOX VI
- ④ Insulation
- ⑤ Fixing insulation
- ⑥ Profile MFT-CP T
- ⑦ Self drilling screw
- ⑧ Ventilation gap
- ⑨ Aluminum-bolt MFT-C BO
- ⑩ Clip MFT-C
- ⑪ Fixing cladding
- ⑫ Cladding

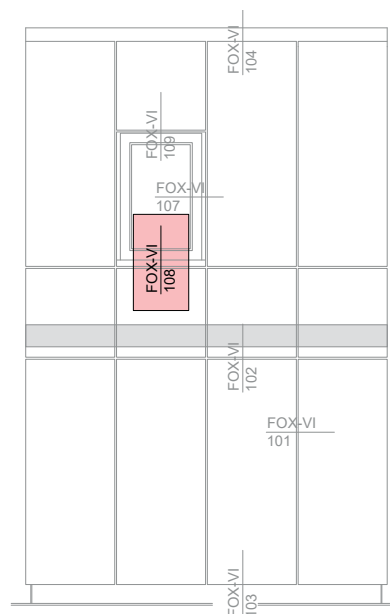
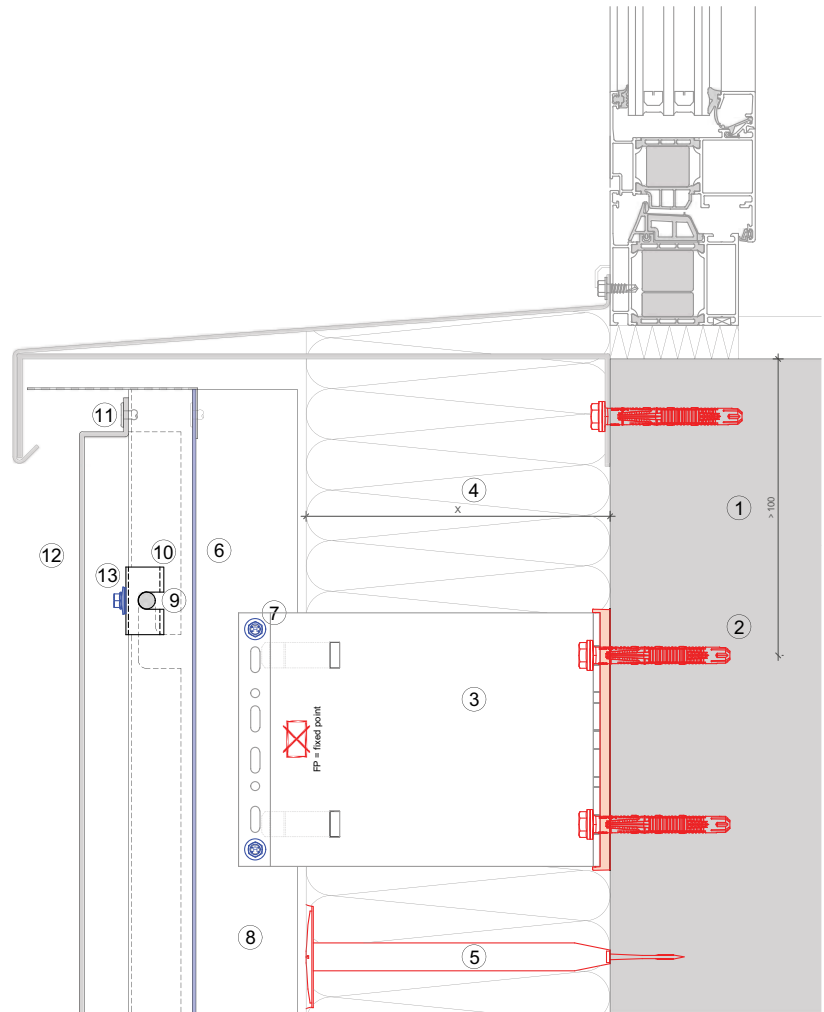

MFT-FOX VI 109

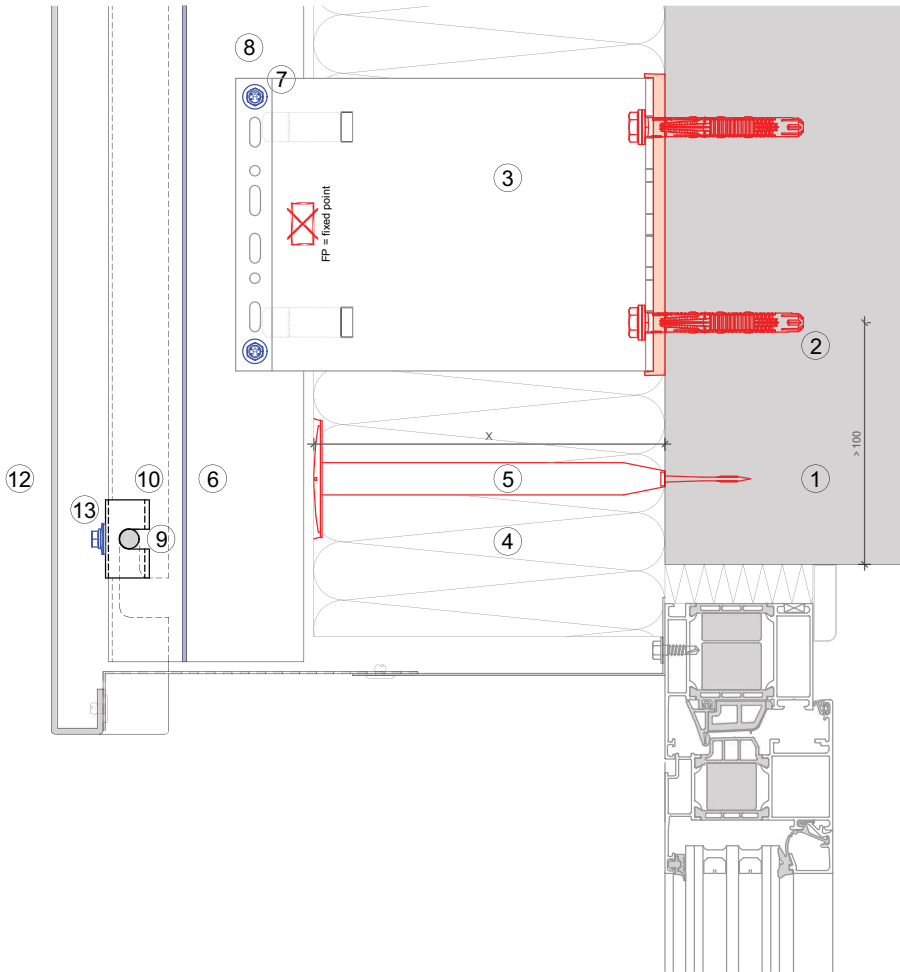

Legend:

- ① Base material
- ② Anchor acc. to static
- ③ Bracket and isolator MFT-FOX VI
- ④ Insulation
- ⑤ Fixing insulation
- ⑥ Profile MFT-CP T
- ⑦ Self drilling screw
- ⑧ Ventilation gap
- ⑨ Aluminum-bolt MFT-C BO
- ⑩ Clip MFT-C
- ⑫ Cladding

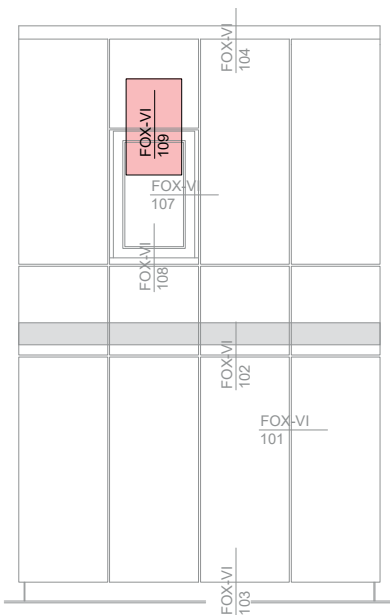

MFT-FOX VI 109

Legend:

- ① Base material
- ② Anchor acc. to static
- ③ Bracket and isolator MFT-FOX VI
- ④ Insulation
- ⑤ Fixing insulation
- ⑥ Profile MFT-CP T
- ⑦ Self drilling screw
- ⑧ Ventilation gap
- ⑨ Aluminum-bolt MFT-C BO
- ⑩ Clip MFT-C
- ⑫ Cladding

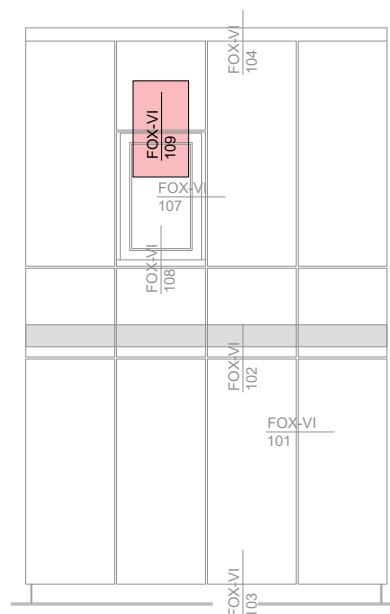
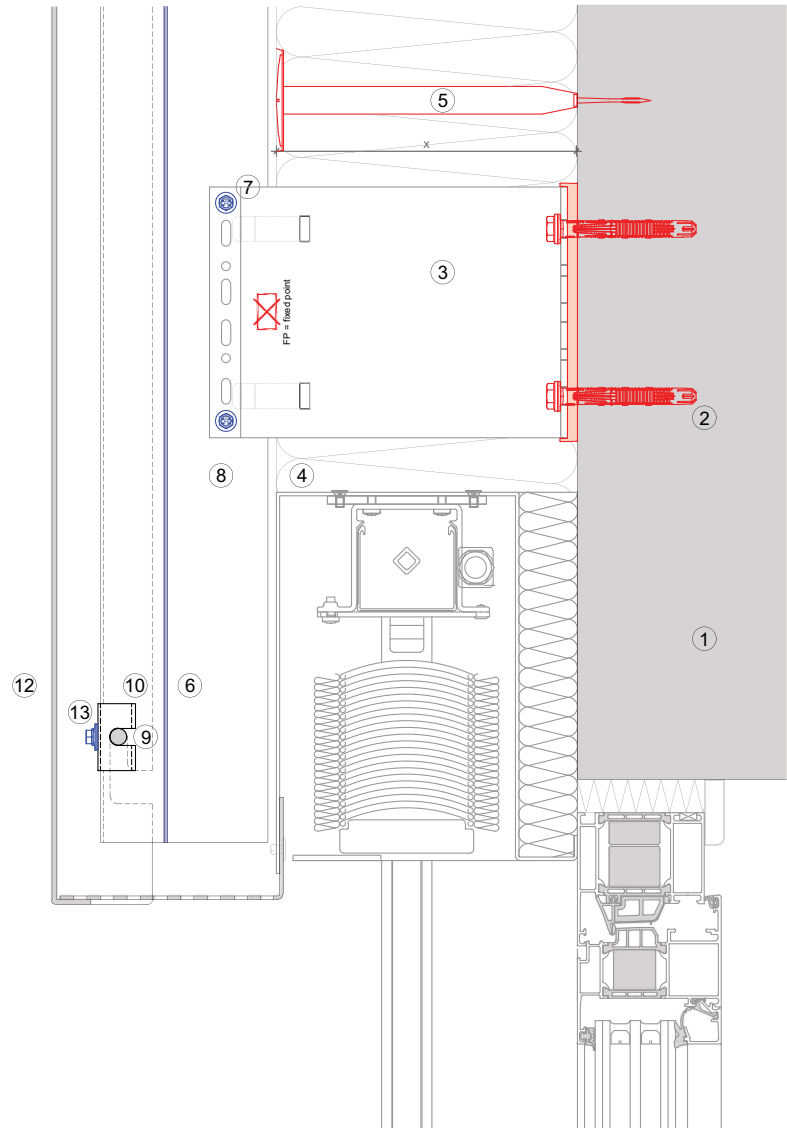

TIPOLOGIE DI STAFFE

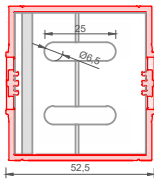
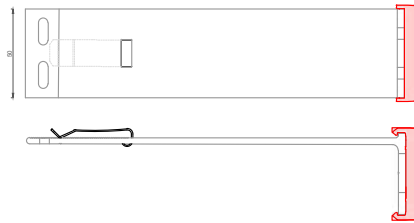

Direct fastening and Screws

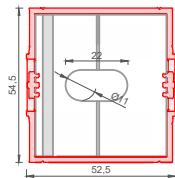

Anchors

MFT-FOX VI Small

Order description	Item No.	Length
DIRECT FASTENING and SCREWS D=6,5 mm		
MFT-FOX VI 40 S 6.5	2305768	40 mm
MFT-FOX VI 60 S 6.5	2305769	60 mm
MFT-FOX VI 80 S 6.5	2305892	80 mm
MFT-FOX VI 100 S 6.5	2305893	100 mm
MFT-FOX VI 120 S 6.5	2305894	120 mm
MFT-FOX VI 140 S 6.5	2305895	140 mm
MFT-FOX VI 160 S 6.5	2305896	160 mm
MFT-FOX VI 180 S 6.5	2305891	180 mm
MFT-FOX VI 200 S 6.5	2305890	200 mm
MFT-FOX VI 220 S 6.5	2305889	220 mm
MFT-FOX VI 240 S 6.5	2305888	240 mm
MFT-FOX VI 260 S 6.5	2305887	260 mm
MFT-FOX VI 280 S 6.5	2305886	280 mm
MFT-FOX VI 300 S 6.5	2305885	300 mm
ANCHORS D=11 mm		
MFT-FOX VI 40 S 11	2305884	40 mm
MFT-FOX VI 60 S 11	2305883	60 mm
MFT-FOX VI 80 S 11	2305882	80 mm
MFT-FOX VI 100 S 11	2305881	100 mm
MFT-FOX VI 120 S 11	2305880	120 mm
MFT-FOX VI 140 S 11	2305897	140 mm
MFT-FOX VI 160 S 11	2305898	160 mm
MFT-FOX VI 180 S 11	2305899	180 mm
MFT-FOX VI 200 S 11	2305900	200 mm
MFT-FOX VI 220 S 11	2305901	220 mm
MFT-FOX VI 240 S 11	2305902	240 mm
MFT-FOX VI 260 S 11	2305903	260 mm
MFT-FOX VI 280 S 11	2305904	280 mm
MFT-FOX VI 300 S 11	2305905	300 mm

The length shown includes the isolator thickness.

TIPOLOGIE DI STAFFE

MFT-FOX VI Medium

Order description	Item No.	Length
DIRECT FASTENING, SCREWS D=6,5 mm and ANCHORS D=11 mm		
MFT-FOX VI 40 M 6.5 / 11	2305984	40 mm
MFT-FOX VI 60 M 6.5 / 11	2305983	60 mm
MFT-FOX VI 80 M 6.5 / 11	2305982	80 mm
MFT-FOX VI 100 M 6.5 / 11	2305981	100 mm
MFT-FOX VI 120 M 6.5 / 11	2305980	120 mm
MFT-FOX VI 140 M 6.5 / 11	2305979	140 mm
MFT-FOX VI 160 M 6.5 / 11	2305978	160 mm
MFT-FOX VI 180 M 6.5 / 11	2305977	180 mm
MFT-FOX VI 200 M 6.5 / 11	2305976	200 mm
MFT-FOX VI 220 M 6.5 / 11	2305975	220 mm
MFT-FOX VI 240 M 6.5 / 11	2305974	240 mm
MFT-FOX VI 260 M 6.5 / 11	2305973	260 mm
MFT-FOX VI 280 M 6.5 / 11	2305972	280 mm
MFT-FOX VI 300 M 6.5 / 11	2305971	300 mm

The length shown includes the isolator thickness.

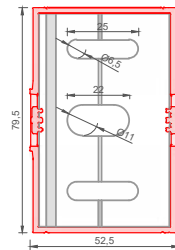
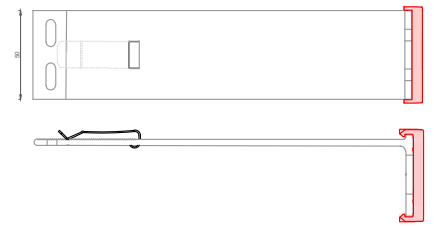

Direct fastening
Screws and
Anchors

TIPOLOGIE DI STAFFE

MFT-FOX VI Large

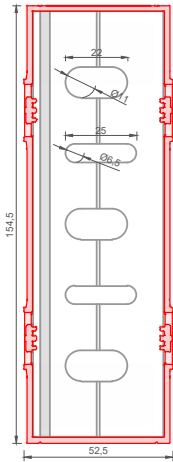
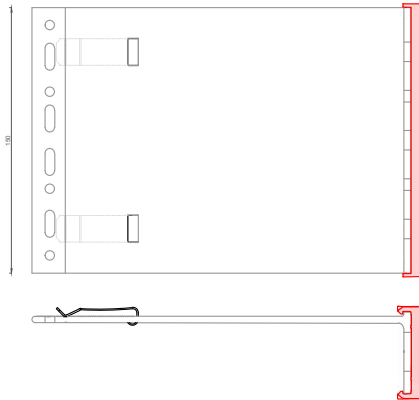

Direct fastening
Screws and
Anchors

Order description	Item No.	Length
DIRECT FASTENING, SCREWS D=6,5 mm and ANCHORS D=11 mm		
MFT-FOX VI 40 L 6.5 / 11	2305950	40 mm
MFT-FOX VI 60 L 6.5 / 11	2305949	60 mm
MFT-FOX VI 80 L 6.5 / 11	2305948	80 mm
MFT-FOX VI 100 L 6.5 / 11	2305947	100 mm
MFT-FOX VI 120 L 6.5 / 11	2305946	120 mm
MFT-FOX VI 140 L 6.5 / 11	2305945	140 mm
MFT-FOX VI 160 L 6.5 / 11	2305944	160 mm
MFT-FOX VI 180 L 6.5 / 11	2305943	180 mm
MFT-FOX VI 200 L 6.5 / 11	2305942	200 mm
MFT-FOX VI 220 L 6.5 / 11	2305941	220 mm
MFT-FOX VI 240 L 6.5 / 11	2305940	240 mm
MFT-FOX VI 260 L 6.5 / 11	2305939	260 mm
MFT-FOX VI 280 L 6.5 / 11	2305938	280 mm
MFT-FOX VI 300 L 6.5 / 11	2305937	300 mm

The length shown includes the isolator thickness.

CAPACITÀ DI REGOLAZIONE

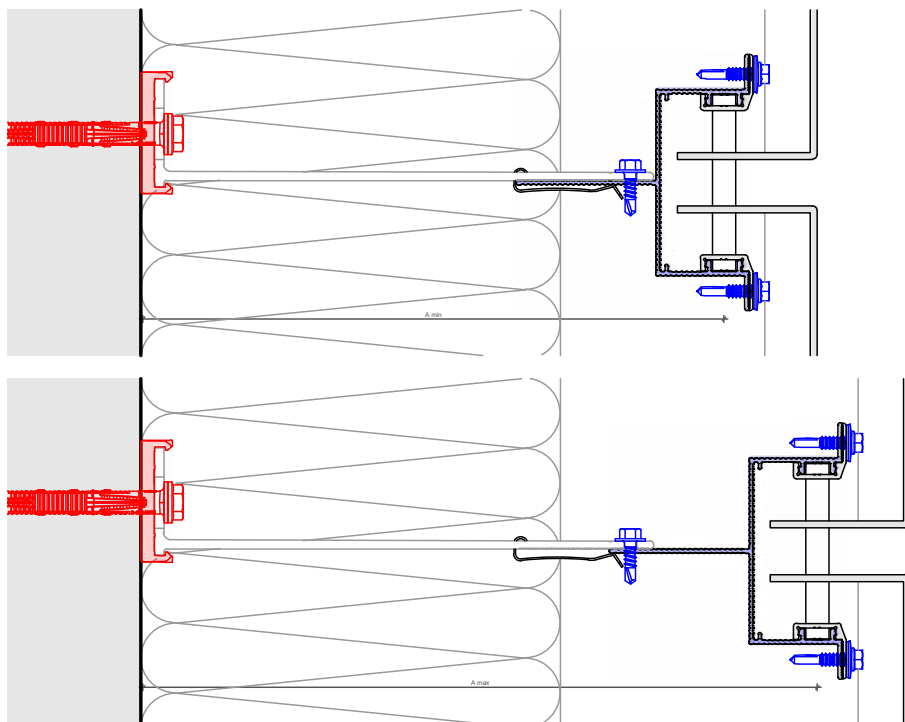

Profile	MFT-CP-T 40x80x1,9 6 m	
	A min	A max
Brackets		
MFT-FOX VI 40 S/M/L 6,5/11	105	109,25
MFT-FOX VI 60 S/M/L 6,5/11	105	129,25
MFT-FOX VI 80 S/M/L 6,5/11	110	149,25
MFT-FOX VI 100 S/M/L 6,5/11	130	169,25
MFT-FOX VI 120 S/M/L 6,5/11	150	189,25
MFT-FOX VI 140 S/M/L 6,5/11	170	209,25
MFT-FOX VI 160 S/M/L 6,5/11	190	229,25
MFT-FOX VI 180 S/M/L 6,5/11	210	249,25
MFT-FOX VI 200 S/M/L 6,5/11	230	269,25
MFT-FOX VI 220 S/M/L 6,5/11	250	289,25
MFT-FOX VI 240 S/M/L 6,5/11	270	309,25
MFT-FOX VI 260 S/M/L 6,5/11	290	329,25
MFT-FOX VI 280 S/M/L 6,5/11	310	349,25
MFT-FOX VI 300 S/M/L 6,5/11	330	369,25

* The distance shown is valid for profile of 1,8 mm.

PRODOTTI**Bracket fastener**

HUS-HR



HRD-H



HST-R



HSA-R



HIT-HY 270



HIT-HY 200-A



S-MP 53S



S-MD 51S / S-MD 53S / S-MD 55S

**Direct fastening:**

Powder-actuated tool



Universal nail X-CR P8



DX cartridge 6.8/11 M10

**Brackets**

MFT-FOX VI Small



MFT-FOX VI Medium



MFT-FOX VI Large



PRODOTTI

Profile

MFT-L



MFT-CP T



Profile to bracket fastene

S-AD 01S



Other Accessories

MFT-C



MFT-C BO



Insulation fasteners

Insulation fasteners

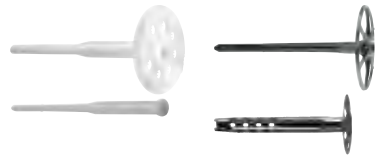



Hilti Italia
Piazza Idro Montanelli, 20
20099 Sesto San Giovanni (MI)

800-827013
www.hilti.it
   