

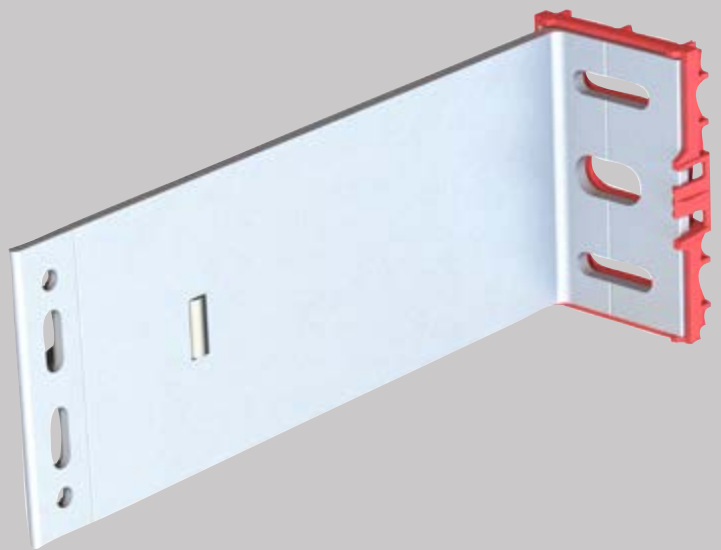

MFT-FOX VI-2L- SZ-20

**Sistema di Facciata Ventilata
Hilti**



CONTENUTI

Pannelli	3
Applicazione e Descrizione	4
Disegni di Sistema	5-17
Tipologie di Staffe	
MFT-FOX VI Small	18
MFT-FOX VI Medium	19
MFT-FOX VI Large	20
Capacità di Regolazione	21
Prodotti	22-23

MFT-FOX VI-2L-SZ-20



Metal



Composite





APPLICAZIONE E DESCRIZIONE

MFT-FOX VI-2L-SZ-20

Il sistema consiste in mensole a muro e profili ed è progettato specificamente per sottostrutture verticali/orizzontali con un sistema di profili orizzontale aggiuntivo per il fissaggio di cassette in alluminio composito (ACM) nelle facciate ventilate.

Le mensole sono fornite con elementi isolanti preassemblati e, secondo il metodo di installazione al materiale base (tasselli, viti o fissaggio diretto), con diverse geometrie dei fori nella piastra base (le geometrie dei fori disponibili sono illustrate nel catalogo o nelle pagine seguenti).

Le mensole sono progettate con punti sia fissi che flessibili, per consentire l'espansione termica del profilo. Il punto fisso assorbe il peso dei pannelli e della sottostruttura e i carichi del vento proporzionali, mentre il punto flessibile assorbe solo i carichi del vento proporzionali.

I profili verticali sono connessi alle mensole con viti appositamente studiate per punti fissi e flessibili. I punti fissi non consentono il movimento verticale dei profili contro le mensole, mentre i punti flessibili consentono uno scorrimento, praticamente senza attrito, dei profili contro le mensole. Il punto flessibile consente di evitare l'aggiunta di carichi alla sottostruttura a seguito delle forze di espansione del profilo.

L'adattamento dei profili rispetto alle mensole è agevolato da un elemento ausiliario. Tale elemento ausiliario tiene il profilo in posizione mentre questo viene fissato con viti, in modo da rendere più rapido il processo di connessione alla mensola. Con questo sistema, è possibile compensare perfettamente una tolleranza dimensionale delle pareti fino a 40 mm. Le mensole sono disponibili in 3 diverse misure (grande, media e piccola), da 40 mm a 300 mm, incluso un elemento isolante di 6 mm, con incrementi di 20 mm. L'elemento isolante separa la sottostruttura dal materiale base, per ridurre il ponte termico.

I profili orizzontali (Start, S e Z) saranno fissati con viti in acciaio inox sulla sottostruttura verticale. Il profilo consente il fissaggio delle cassette con distanze differenti dalla parete per creare degli aggetti.

Vantaggi

- Design flessibile con punti fissi e flessibili
- Tre diverse misure: grande, media e piccola
- Adattamento della mensola rispetto al profilo fino a 40 mm
- Le mensole possono essere montate con diversi metodi: tasselli, viti o fissaggio diretto
- Un elemento isolante di 6 mm separa la sottostruttura dal materiale base, per ridurre il ponte termico
- Le sottostrutture possono essere dimensionate mediante il software PROFIS Facade, per generare soluzioni tecnicamente accettabili e ottimizzate dal punto di vista economico
- Possono essere utilizzate con tutte le cassette in alluminio di uso più comune

DISEGNI DI SISTEMA

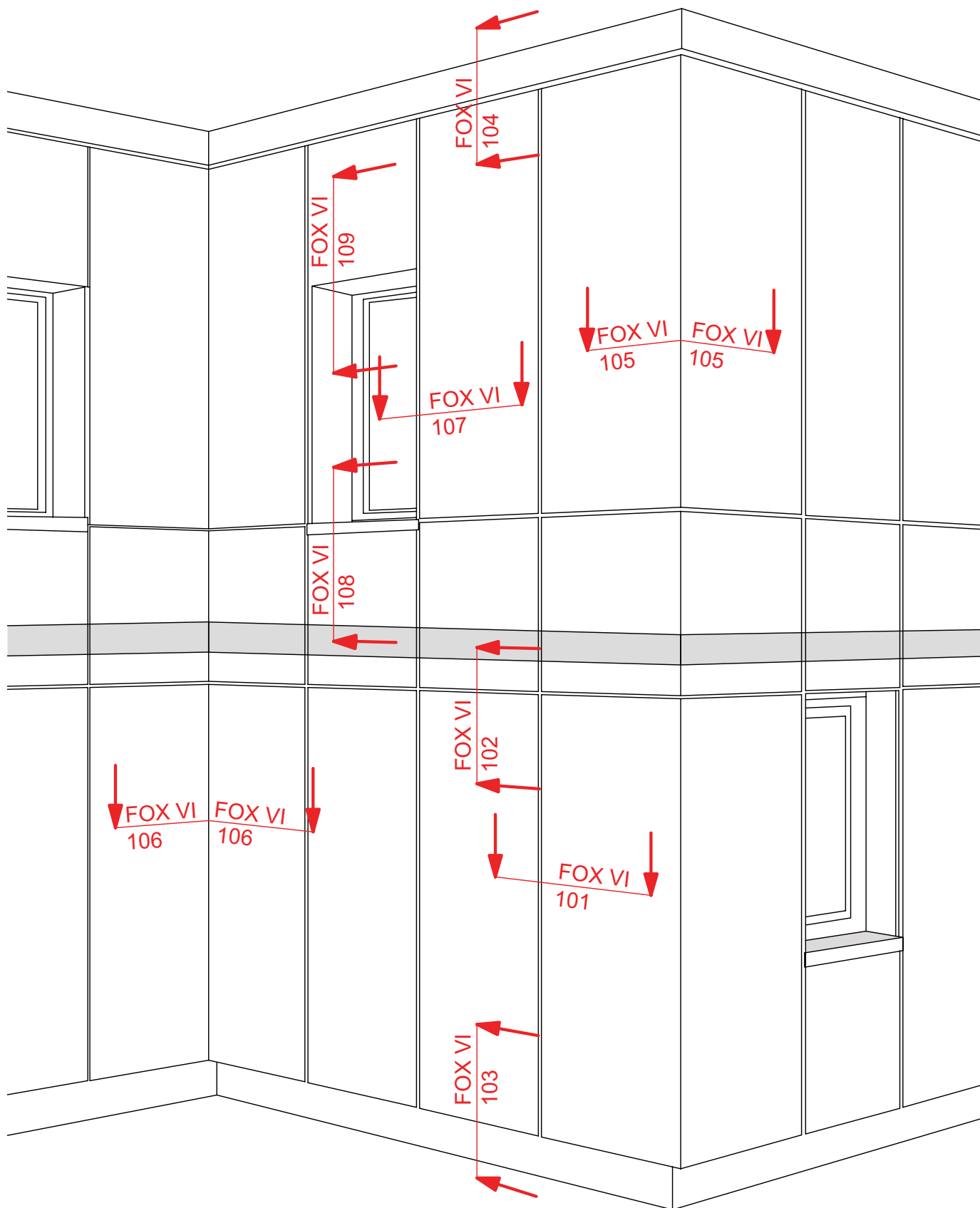

MFT-FOX VI 101

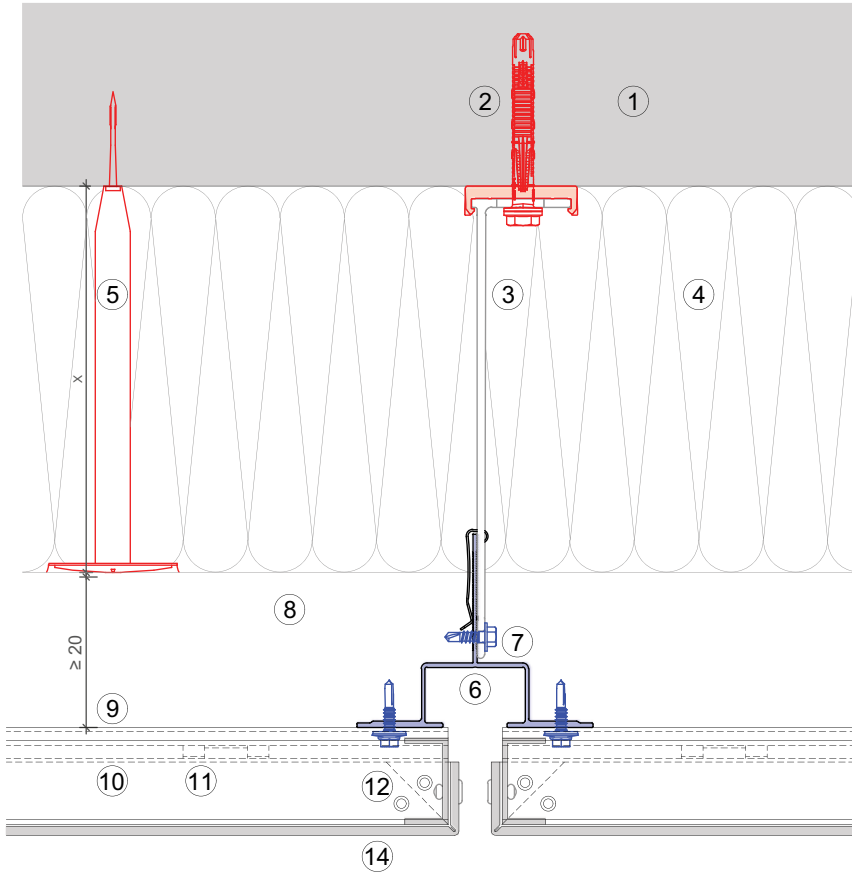

Legend:

- ① Base material
- ② Anchor acc. to static
- ③ Bracket and isolator
- ④ Insulation
- ⑤ Fixing insulation
- ⑥ Profile
- ⑦ Self drilling screw
- ⑧ Ventilation gap
- ⑨ Z-profile
- ⑩ S-profile
- ⑪ Plastic clips
- ⑫ Rivet
- ⑭ Cladding

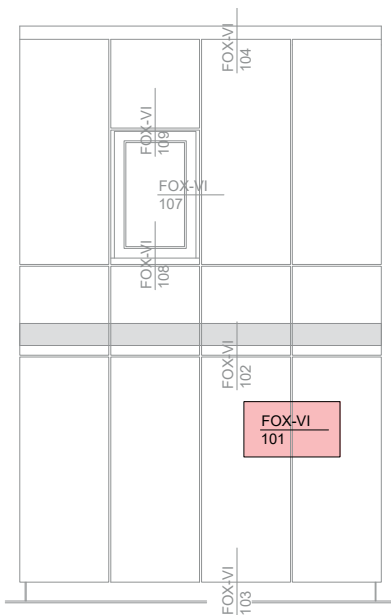

MFT-FOX VI 101

Legend:

- ① Base material
- ② Anchor acc. to static
- ③ Bracket and isolator
- ④ Insulation
- ⑤ Fixing insulation
- ⑥ Profile
- ⑦ Self drilling screw
- ⑧ Ventilation gap
- ⑨ Z-profile
- ⑩ S-profile
- ⑪ Plastic clips
- ⑫ Rivet
- ⑭ Cladding

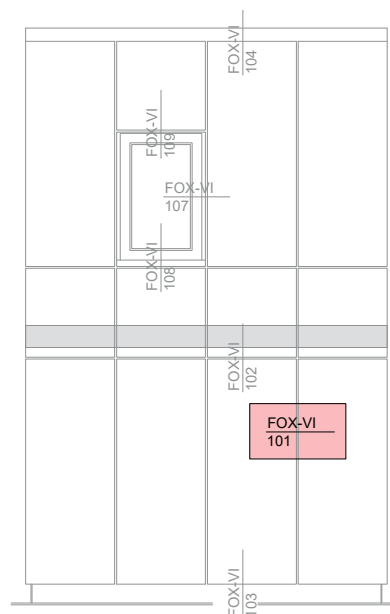
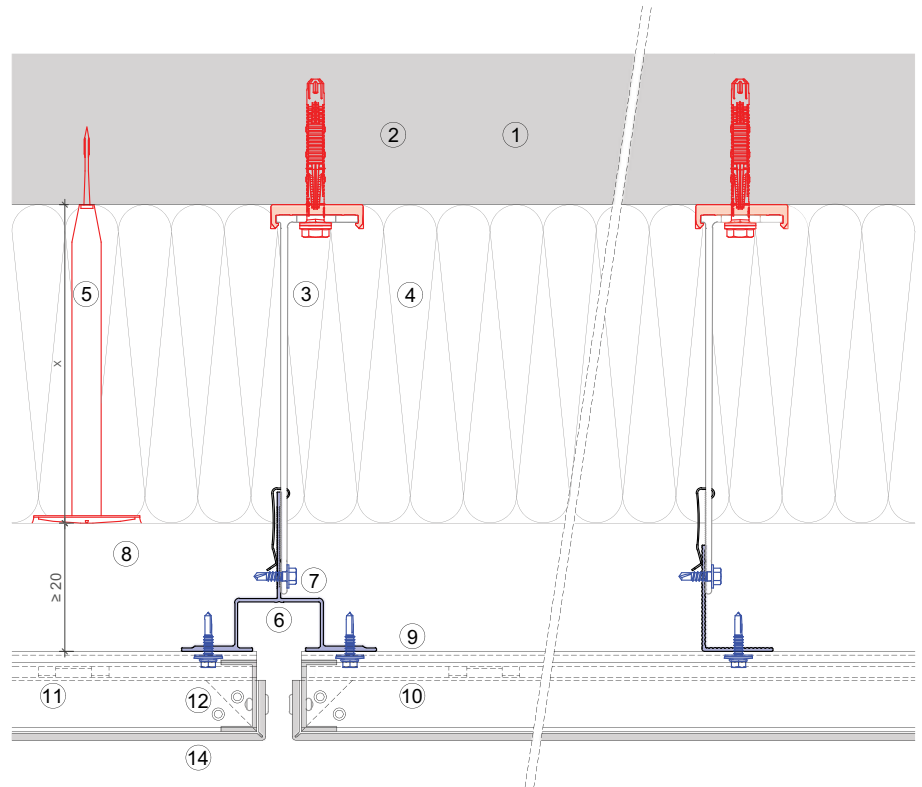

MFT-FOX VI 102

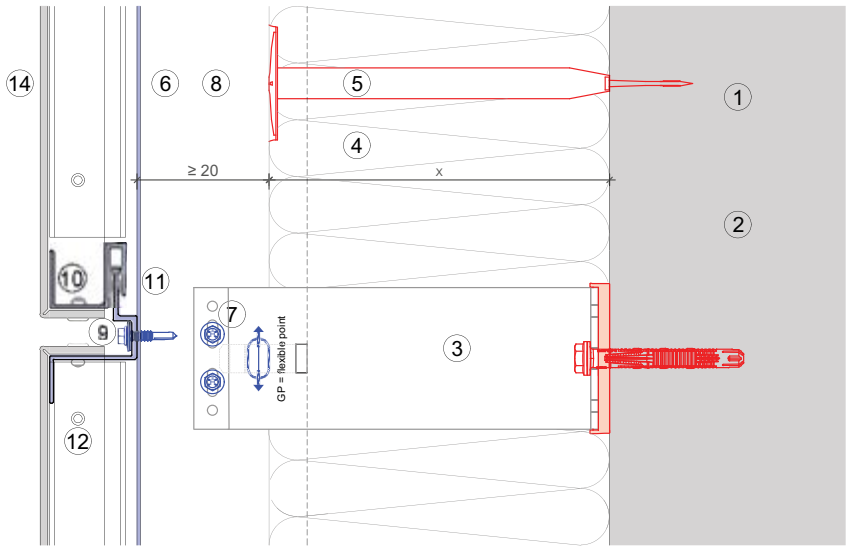

Legend:

- ① Base material
- ② Anchor acc. to static
- ③ Bracket and isolator
- ④ Insulation
- ⑤ Fixing insulation
- ⑥ Profile
- ⑦ Self drilling screw
- ⑧ Ventilation gap
- ⑨ Z-profile
- ⑩ S-profile
- ⑪ Plastic clips
- ⑫ Rivet
- ⑬ Cladding

Vertical section-fixed point

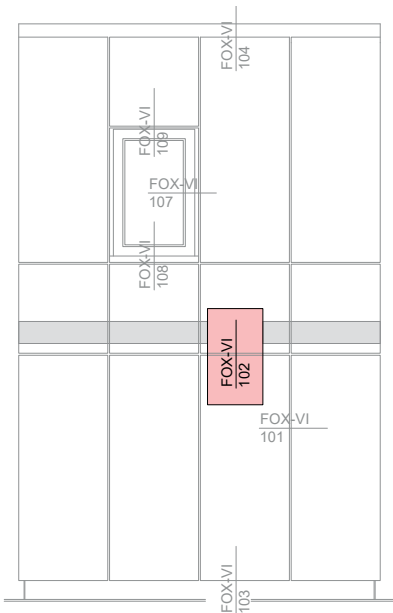
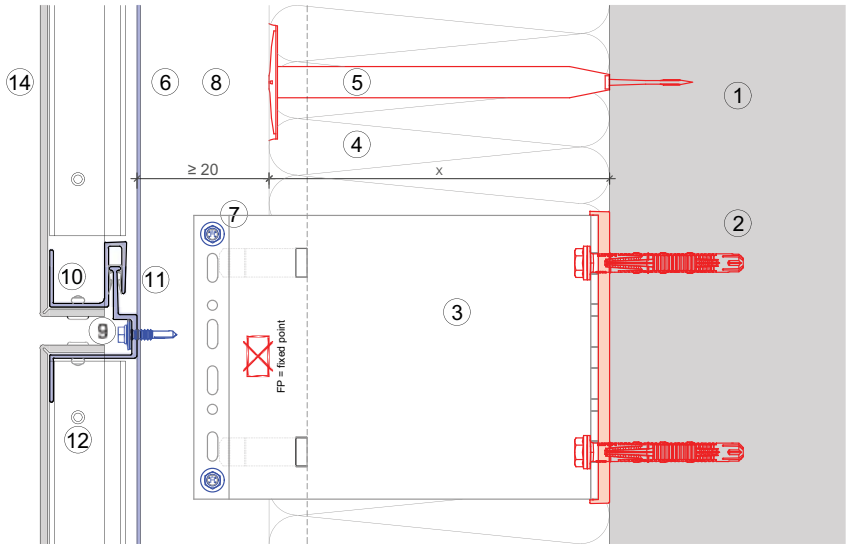

MFT-FOX VI 103

Legend:

- ① Base material
- ② Anchor acc. to static
- ③ Bracket and isolator
- ④ Insulation
- ⑤ Fixing insulation
- ⑥ Profile
- ⑦ Self drilling screw
- ⑧ Ventilation gap
- ⑨ Z-profile
- ⑩ S-profile
- ⑪ Plastic clips
- ⑫ Rivet
- ⑬ Base profile
- ⑭ Cladding

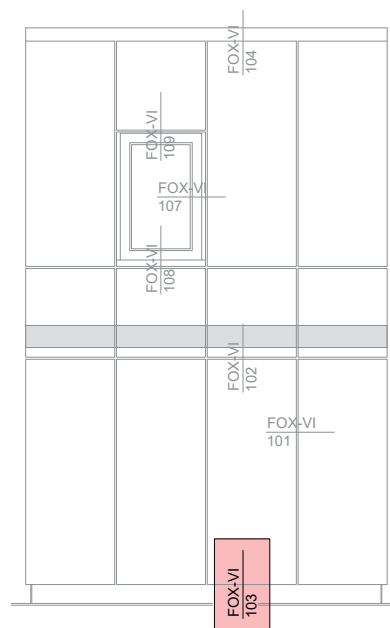
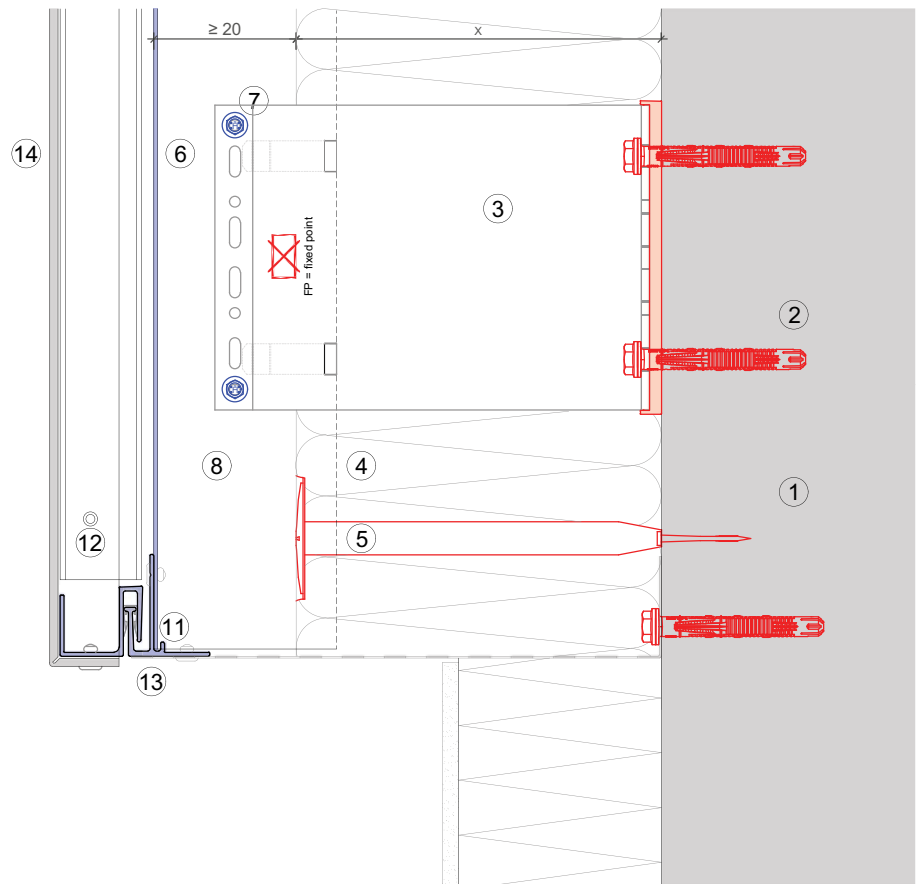

MFT-FOX VI 104

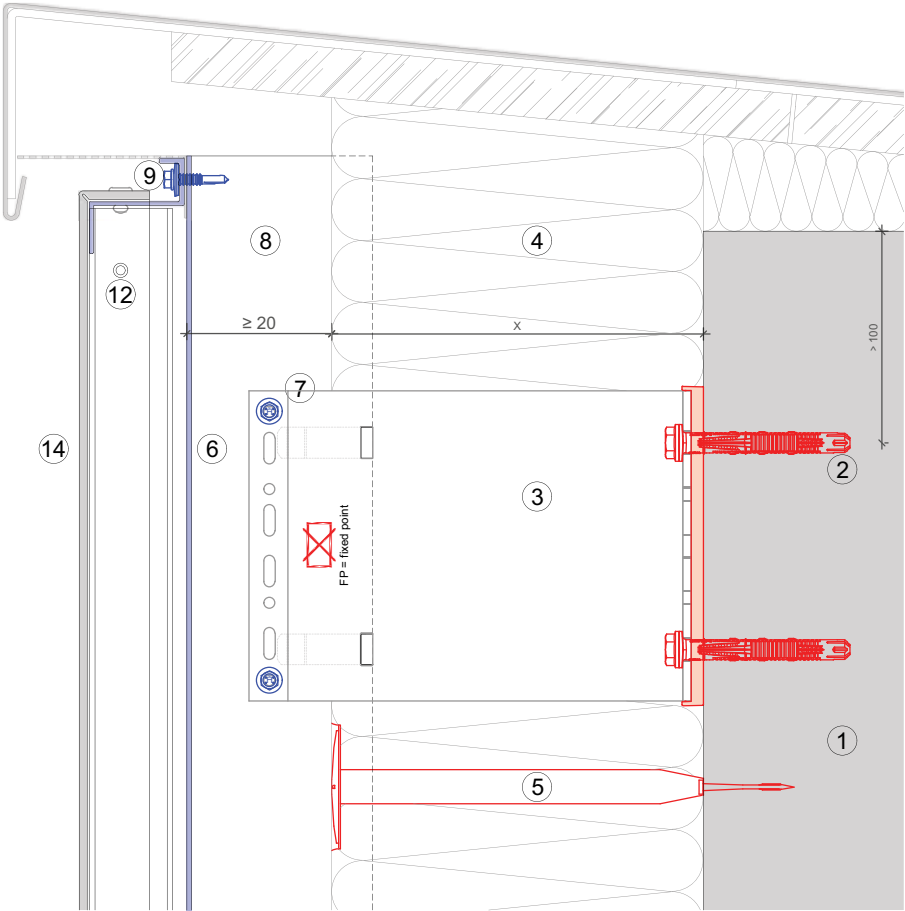

Legend:

- ① Base material
- ② Anchor acc. to static
- ③ Bracket and isolator
- ④ Insulation
- ⑤ Fixing insulation
- ⑥ Profile
- ⑦ Self drilling screw
- ⑧ Ventilation gap
- ⑨ Z-profile
- ⑩ S-profile
- ⑪ Plastic clips
- ⑫ Rivet
- ⑭ Cladding

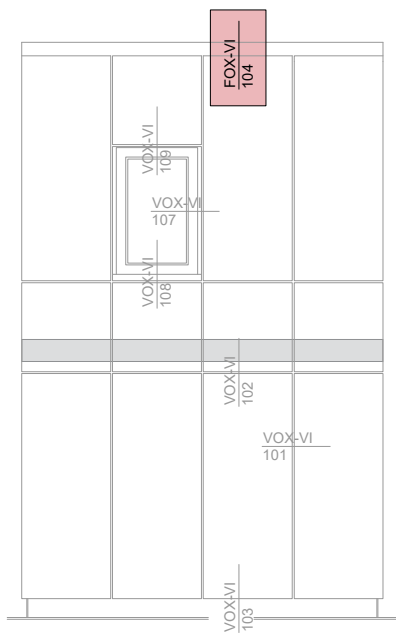

MFT-FOX VI 105

Legend:

- ① Base material
- ② Anchor acc. to static
- ③ Bracket and isolator
- ④ Insulation
- ⑤ Fixing insulation
- ⑥ Profile
- ⑦ Self drilling screw
- ⑧ Ventilation gap
- ⑨ Z-profile
- ⑩ S-profile
- ⑪ Plastic clips
- ⑫ Rivet
- ⑬ Cladding

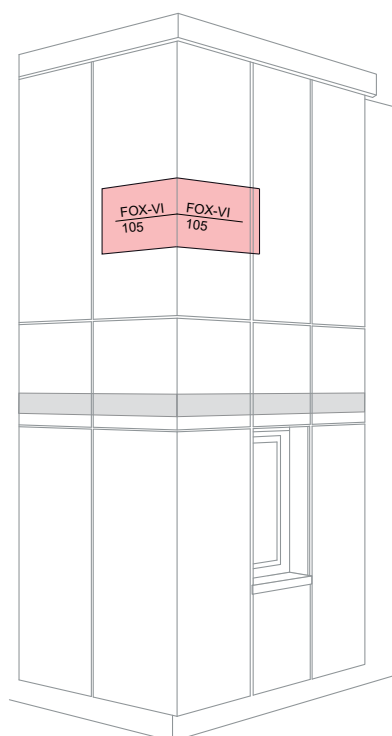
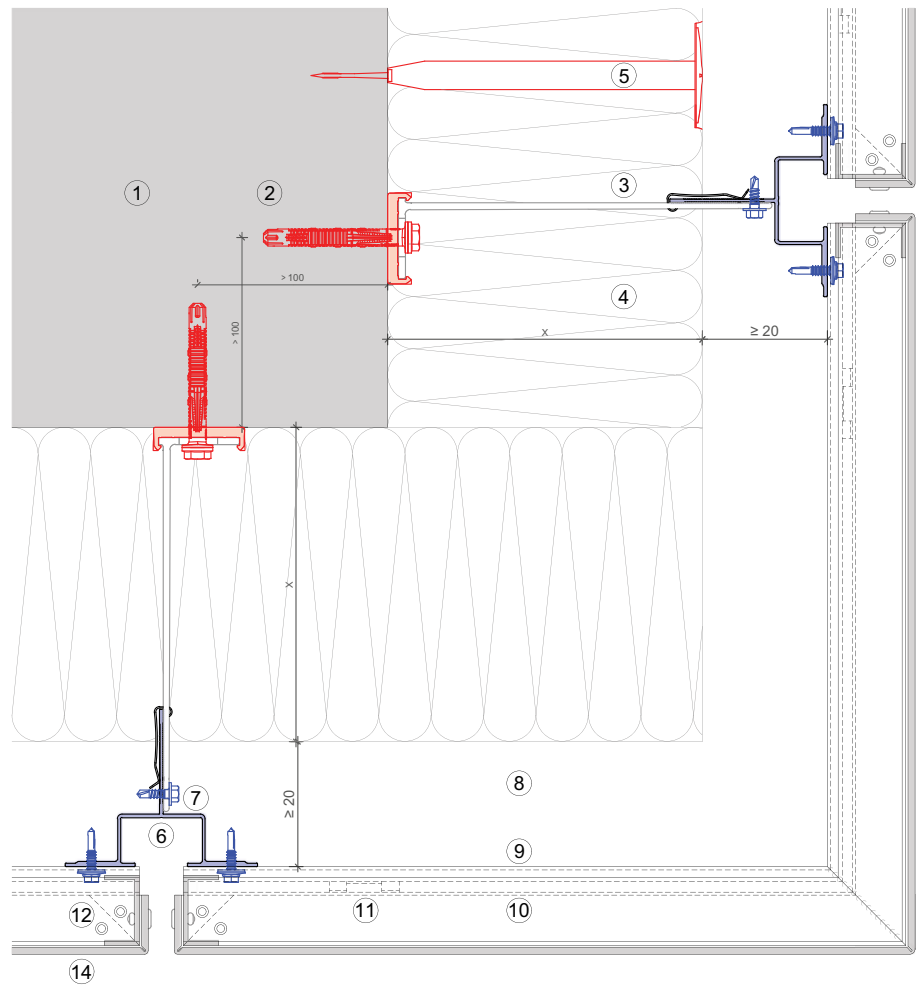

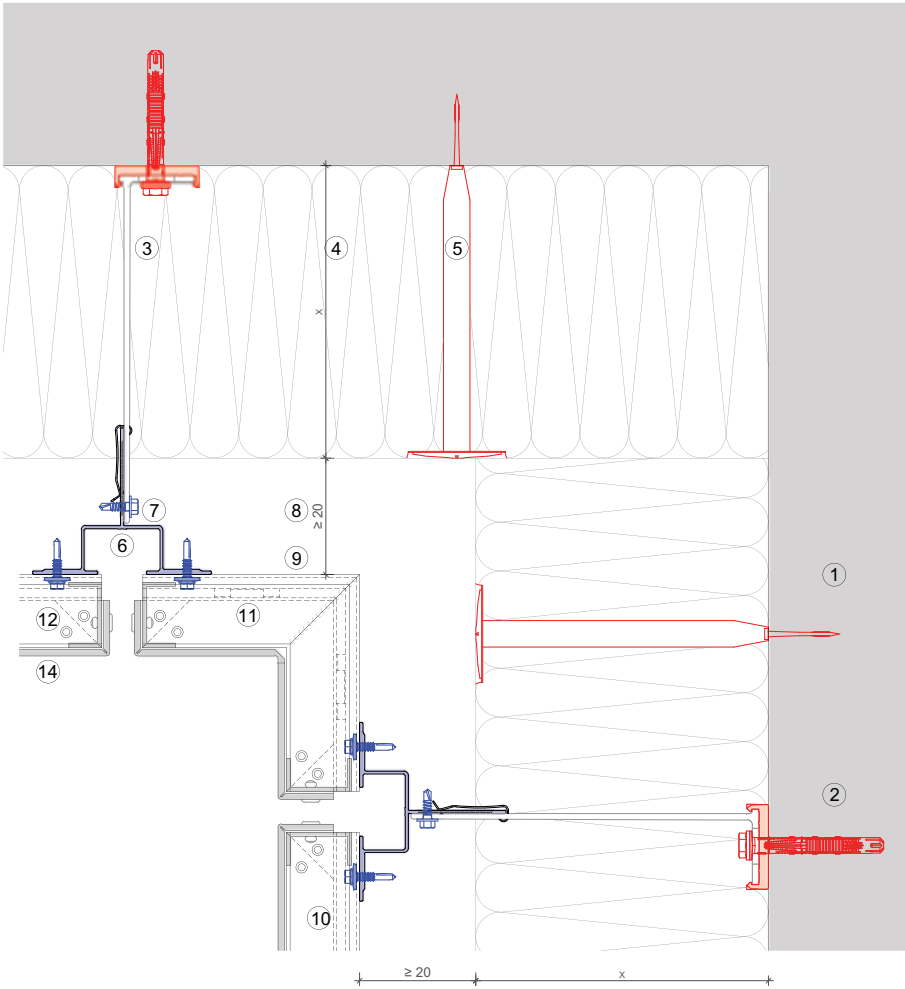

- Legend:**
- ① Base material
 - ② Anchor acc. to static
 - ③ Bracket and isolator
 - ④ Insulation
 - ⑤ Fixing insulation
 - ⑥ Profile
 - ⑦ Self drilling screw
 - ⑧ Ventilation gap
 - ⑨ Z-profile
 - ⑩ S-profile
 - ⑪ Plastic clips
 - ⑫ Rivet
 - ⑭ Cladding

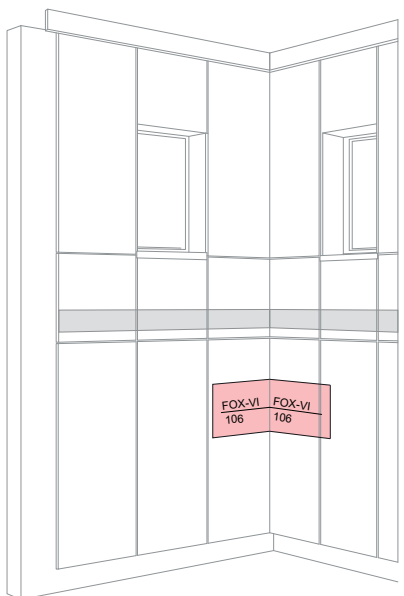

MFT-FOX VI 107

Legend:

- ① Base material
- ② Anchor acc. to static
- ③ Bracket and isolator
- ④ Insulation
- ⑤ Fixing insulation
- ⑥ Profile
- ⑦ Self drilling screw
- ⑧ Ventilation gap
- ⑨ Z-profile
- ⑩ S-profile
- ⑪ Plastic clips
- ⑫ Rivet
- ⑭ Cladding

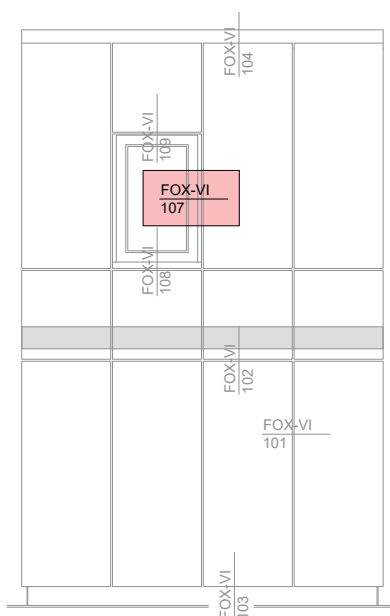
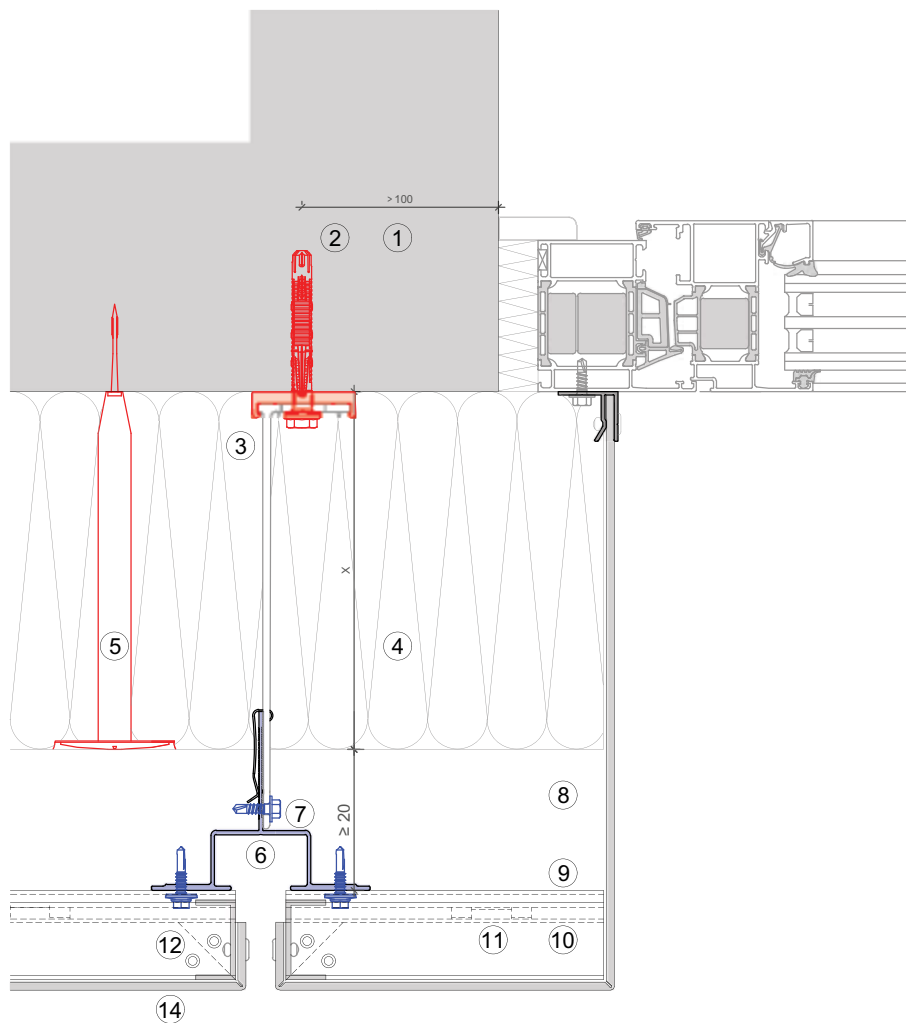

MFT-FOX VI 107

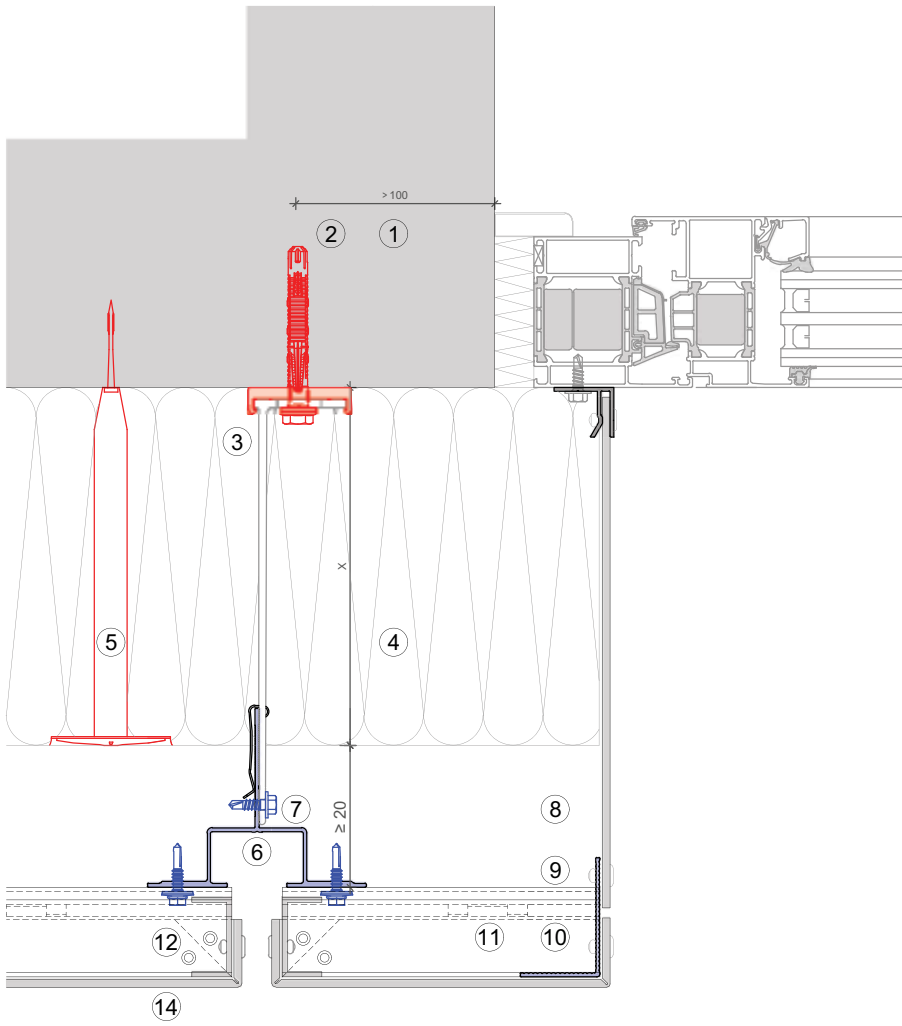

Legend:

- ① Base material
- ② Anchor acc. to static
- ③ Bracket and isolator
- ④ Insulation
- ⑤ Fixing insulation
- ⑥ Profile
- ⑦ Self drilling screw
- ⑧ Ventilation gap
- ⑨ Z-profile
- ⑩ S-profile
- ⑪ Plastic clips
- ⑫ Rivet
- ⑬ Cladding

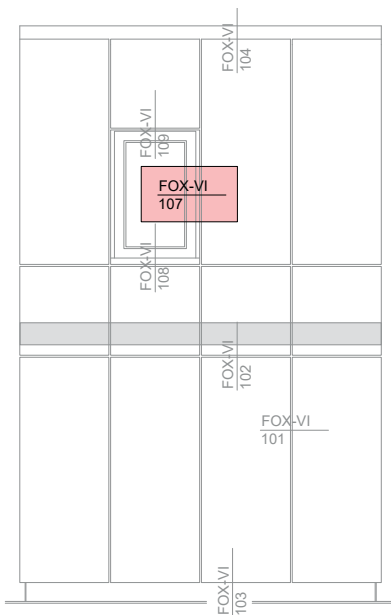

MFT-FOX VI 108

Legend:

- ① Base material
- ② Anchor acc. to static
- ③ Bracket and isolator
- ④ Insulation
- ⑤ Fixing insulation
- ⑥ Profile
- ⑦ Self drilling screw
- ⑧ Ventilation gap
- ⑨ Z-profile
- ⑩ S-profile
- ⑪ Plastic clips
- ⑫ Rivet
- ⑭ Cladding

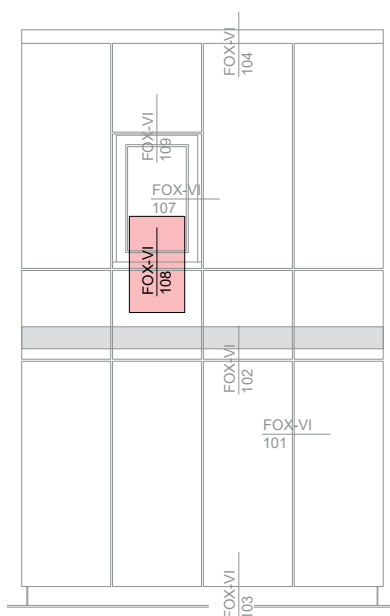
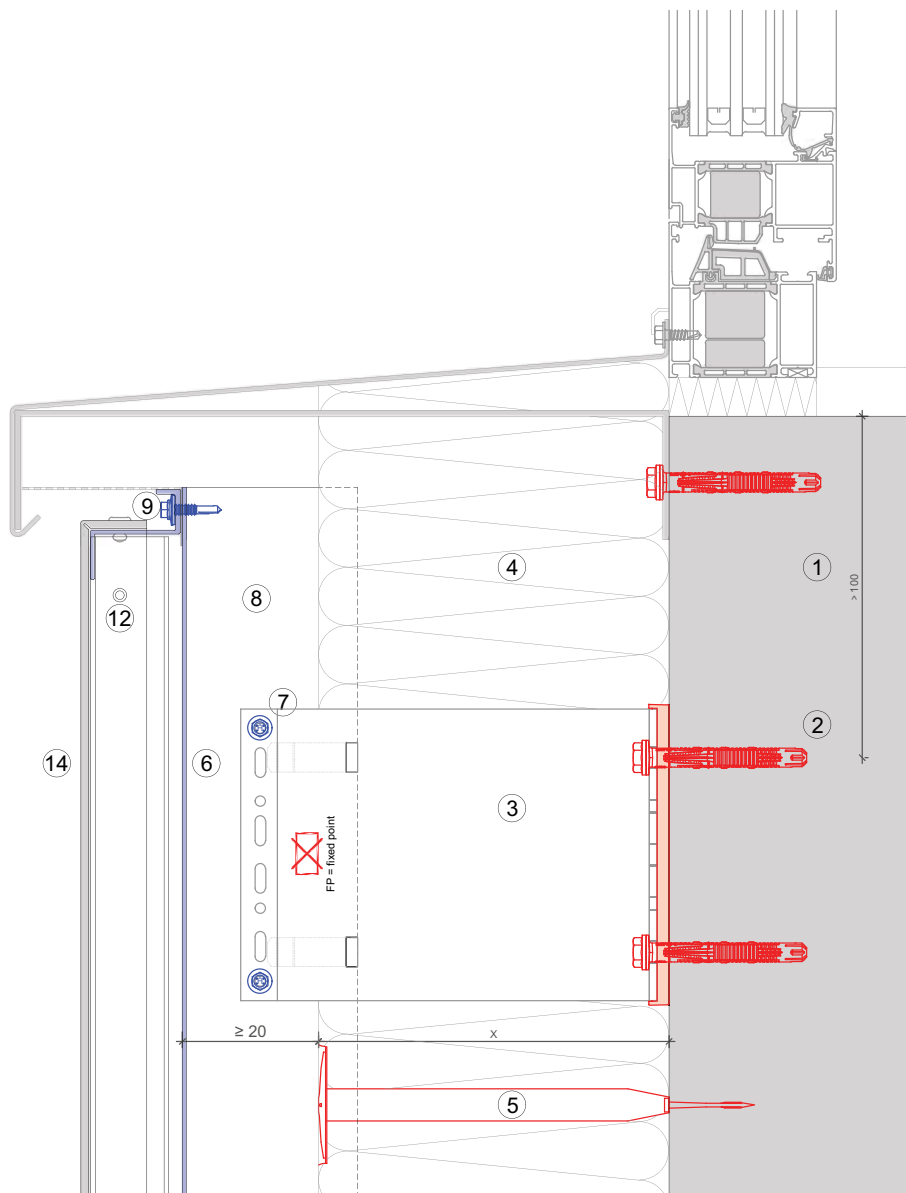

MFT-FOX VI 109

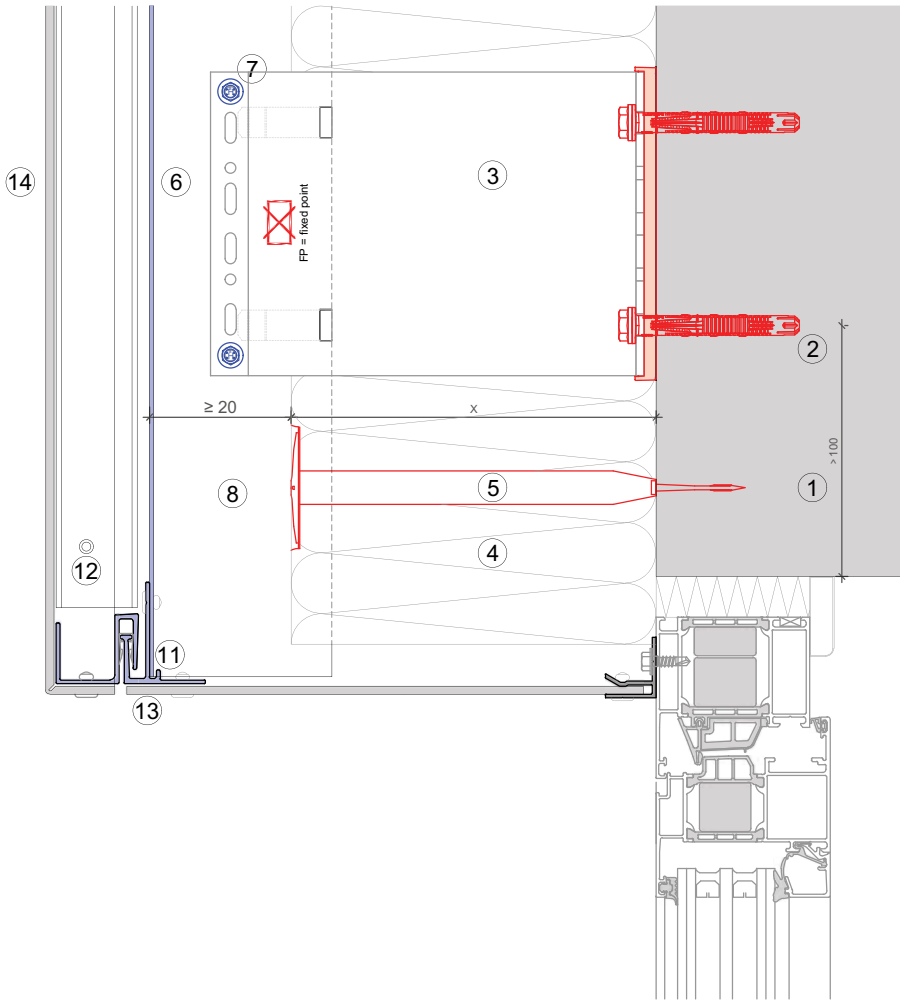

Legend:

- ① Base material
- ② Anchor acc. to static
- ③ Bracket and isolator
- ④ Insulation
- ⑤ Fixing insulation
- ⑥ Profile
- ⑦ Self drilling screw
- ⑧ Ventilation gap
- ⑨ Z-profile
- ⑩ S-profile
- ⑪ Plastic clips
- ⑫ Rivet
- ⑬ Base profile
- ⑭ Cladding

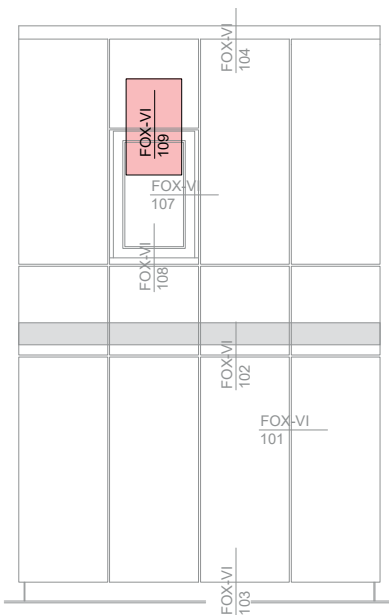

MFT-FOX VI 109

Legend:

- ① Base material
- ② Anchor acc. to static
- ③ Bracket and isolator
- ④ Insulation
- ⑤ Fixing insulation
- ⑥ Profile
- ⑦ Self drilling screw
- ⑧ Ventilation gap
- ⑨ Z-profile
- ⑩ S-profile
- ⑪ Plastic clips
- ⑫ Rivet
- ⑬ Base profile
- ⑭ Cladding

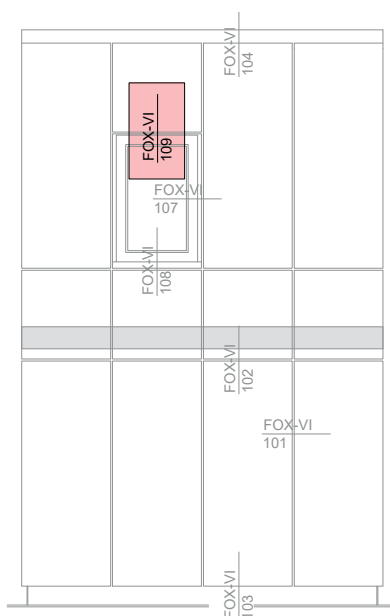
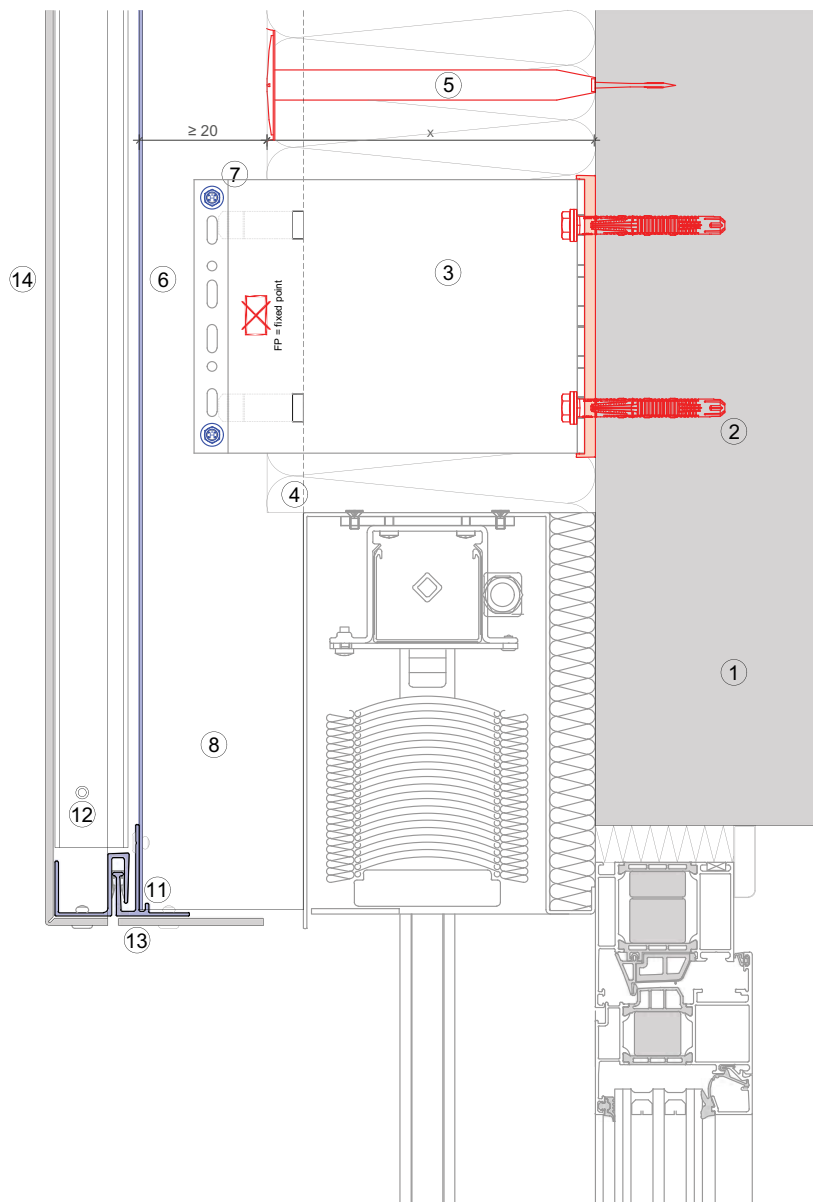

TIPOLOGIE DI STAFFE

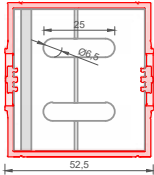
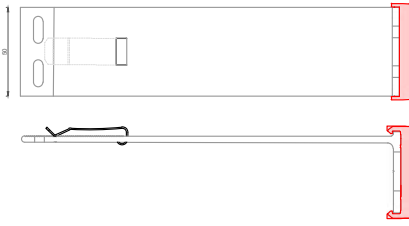

Direct fastening and Screws

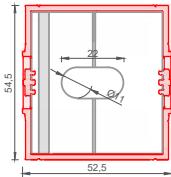

Anchors

MFT-FOX VI Small

Order description	Item No.	Length
DIRECT FASTENING and SCREWS D=6,5 mm		
MFT-FOX VI 40 S 6.5	2305768	40 mm
MFT-FOX VI 60 S 6.5	2305769	60 mm
MFT-FOX VI 80 S 6.5	2305892	80 mm
MFT-FOX VI 100 S 6.5	2305893	100 mm
MFT-FOX VI 120 S 6.5	2305894	120 mm
MFT-FOX VI 140 S 6.5	2305895	140 mm
MFT-FOX VI 160 S 6.5	2305896	160 mm
MFT-FOX VI 180 S 6.5	2305891	180 mm
MFT-FOX VI 200 S 6.5	2305890	200 mm
MFT-FOX VI 220 S 6.5	2305889	220 mm
MFT-FOX VI 240 S 6.5	2305888	240 mm
MFT-FOX VI 260 S 6.5	2305887	260 mm
MFT-FOX VI 280 S 6.5	2305886	280 mm
MFT-FOX VI 300 S 6.5	2305885	300 mm
ANCHORS D=11 mm		
MFT-FOX VI 40 S 11	2305884	40 mm
MFT-FOX VI 60 S 11	2305883	60 mm
MFT-FOX VI 80 S 11	2305882	80 mm
MFT-FOX VI 100 S 11	2305881	100 mm
MFT-FOX VI 120 S 11	2305880	120 mm
MFT-FOX VI 140 S 11	2305897	140 mm
MFT-FOX VI 160 S 11	2305898	160 mm
MFT-FOX VI 180 S 11	2305899	180 mm
MFT-FOX VI 200 S 11	2305900	200 mm
MFT-FOX VI 220 S 11	2305901	220 mm
MFT-FOX VI 240 S 11	2305902	240 mm
MFT-FOX VI 260 S 11	2305903	260 mm
MFT-FOX VI 280 S 11	2305904	280 mm
MFT-FOX VI 300 S 11	2305905	300 mm

The length shown includes the isolator thickness.

TIPOLOGIE DI STAFFE

MFT-FOX VI Medium

Order description	Item No.	Length
DIRECT FASTENING, SCREWS D=6,5 mm and ANCHORS D=11 mm		
MFT-FOX VI 40 M 6.5 / 11	2305984	40 mm
MFT-FOX VI 60 M 6.5 / 11	2305983	60 mm
MFT-FOX VI 80 M 6.5 / 11	2305982	80 mm
MFT-FOX VI 100 M 6.5 / 11	2305981	100 mm
MFT-FOX VI 120 M 6.5 / 11	2305980	120 mm
MFT-FOX VI 140 M 6.5 / 11	2305979	140 mm
MFT-FOX VI 160 M 6.5 / 11	2305978	160 mm
MFT-FOX VI 180 M 6.5 / 11	2305977	180 mm
MFT-FOX VI 200 M 6.5 / 11	2305976	200 mm
MFT-FOX VI 220 M 6.5 / 11	2305975	220 mm
MFT-FOX VI 240 M 6.5 / 11	2305974	240 mm
MFT-FOX VI 260 M 6.5 / 11	2305973	260 mm
MFT-FOX VI 280 M 6.5 / 11	2305972	280 mm
MFT-FOX VI 300 M 6.5 / 11	2305971	300 mm

The length shown includes the isolator thickness.

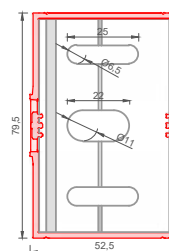
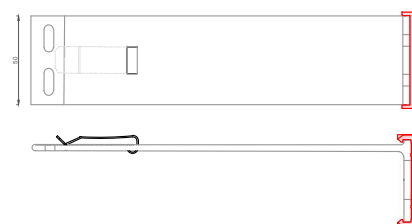

Direct fastening
Screws
and
Anchors

TIPOLOGIE DI STAFFE

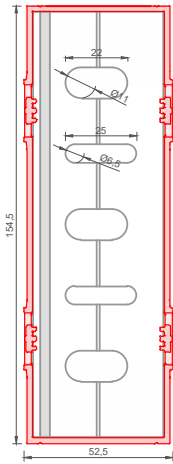
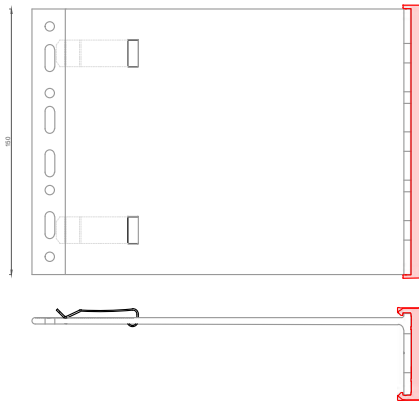

Direct fastening
Screws and
Anchors

MFT-FOX VI Large

Order description	Item No.	Length
DIRECT FASTENING, SCREWS D=6,5 mm and ANCHORS D=11 mm		
MFT-FOX VI 40 L 6.5 / 11	2305950	40 mm
MFT-FOX VI 60 L 6.5 / 11	2305949	60 mm
MFT-FOX VI 80 L 6.5 / 11	2305948	80 mm
MFT-FOX VI 100 L 6.5 / 11	2305947	100 mm
MFT-FOX VI 120 L 6.5 / 11	2305946	120 mm
MFT-FOX VI 140 L 6.5 / 11	2305945	140 mm
MFT-FOX VI 160 L 6.5 / 11	2305944	160 mm
MFT-FOX VI 180 L 6.5 / 11	2305943	180 mm
MFT-FOX VI 200 L 6.5 / 11	2305942	200 mm
MFT-FOX VI 220 L 6.5 / 11	2305941	220 mm
MFT-FOX VI 240 L 6.5 / 11	2305940	240 mm
MFT-FOX VI 260 L 6.5 / 11	2305939	260 mm
MFT-FOX VI 280 L 6.5 / 11	2305938	280 mm
MFT-FOX VI 300 L 6.5 / 11	2305937	300 mm

The length shown includes the isolator thickness.

CAPACITÀ DI REGOLAZIONE

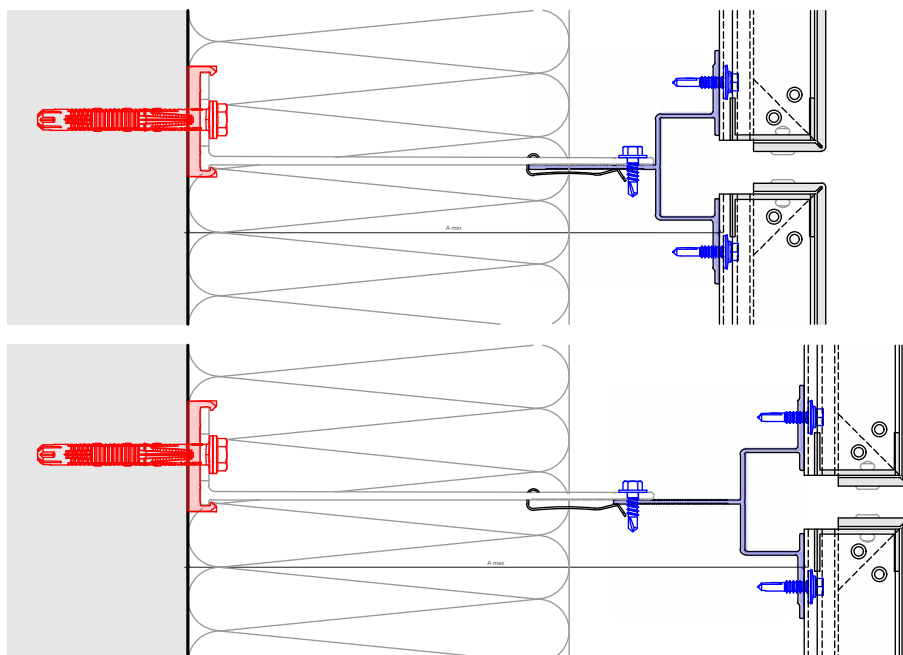

Profiles	MFT-OT 40x30/90x1,8 6m	
Brackets	A min	A max
MFT-FOX VI 40 S/M/L 6,5/11	105.8	110
MFT-FOX VI 60 S/M/L 6,5/11	105.8	130
MFT-FOX VI 80 S/M/L 6,5/11	110.8	150
MFT-FOX VI 100 S/M/L 6,5/11	130.8	170
MFT-FOX VI 120 S/M/L 6,5/11	150.8	190
MFT-FOX VI 140 S/M/L 6,5/11	170.8	210
MFT-FOX VI 160 S/M/L 6,5/11	190.8	230
MFT-FOX VI 180 S/M/L 6,5/11	210.8	250
MFT-FOX VI 200 S/M/L 6,5/11	230.8	270
MFT-FOX VI 220 S/M/L 6,5/11	250.8	290
MFT-FOX VI 240 S/M/L 6,5/11	270.8	310
MFT-FOX VI 260 S/M/L 6,5/11	290.8	330
MFT-FOX VI 280 S/M/L 6,5/11	310.8	350
MFT-FOX VI 300 S/M/L 6,5/11	330.8	370

* The distance shown is valid for profile of 1,8 mm.

PRODOTTI**Bracket fastener**

HUS-HR



HRD-H



HST-R



HSA-R



HIT-HY 270



HIT-HY 200-A



S-MP 53S



S-MD 51S / S-MD 53S / S-MD 55S

**Direct fastening:**

Powder-actuated tool



Universal nail X-CR P8



DX cartridge 6.8/11 M10

**Brackets**

MFT-FOX VI Small



MFT-FOX VI Medium



MFT-FOX VI Large



PRODOTTI

Profiles

MFT-L



MFT-T



MFT-S



MFT-Z



MFT-OT

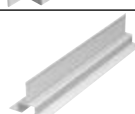

MFT-PE



MFT-PW



Profile to bracket fastener

S-AD 01S



Profile to profile fastener

S-MD 51LS

Accessories to profile fastener

S-AD 01LHSS



Insulation fasteners

Insulation fasteners

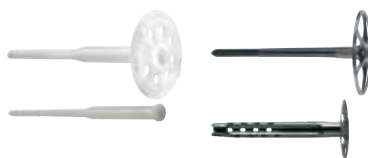



Hilti Italia
Piazza Idro Montanelli, 20
20099 Sesto San Giovanni (MI)

800-827013
www.hilti.it
   