

Approval body for construction products
and types of construction

Bautechnisches Prüfamt

An institution established by the Federal and
Laender Governments



European Technical Assessment

ETA-17/0199
of 3 April 2017

English translation prepared by DIBt - Original version in German language

General Part

Technical Assessment Body issuing the
European Technical Assessment:

Deutsches Institut für Bautechnik

Trade name of the construction product

Injection system Hilti HIT-MM Plus

Product family
to which the construction product belongs

Bonded anchor for use in non-cracked concrete

Manufacturer

Hilti Aktiengesellschaft
9494 SCHAAN
FÜRSTENTUM LIECHTENSTEIN

Manufacturing plant

Hilti Werke

This European Technical Assessment
contains

15 pages including 3 annexes which form an integral part
of this assessment

This European Technical Assessment is
issued in accordance with Regulation (EU)
No 305/2011, on the basis of

Guideline for European technical approval of "Metal
anchors for use in concrete", ETAG 001 Part 5: "Bonded
anchors", April 2013,
used as European Assessment Document (EAD)
according to Article 66 Paragraph 3 of Regulation (EU)
No 305/2011.

The European Technical Assessment is issued by the Technical Assessment Body in its official language. Translations of this European Technical Assessment in other languages shall fully correspond to the original issued document and shall be identified as such.

Communication of this European Technical Assessment, including transmission by electronic means, shall be in full. However, partial reproduction may only be made with the written consent of the issuing Technical Assessment Body. Any partial reproduction shall be identified as such.

This European Technical Assessment may be withdrawn by the issuing Technical Assessment Body, in particular pursuant to information by the Commission in accordance with Article 25(3) of Regulation (EU) No 305/2011.

Specific Part

1 Technical description of the product

The Injection system Hilti HIT-MM Plus is a bonded anchor consisting of a foil pack with injection mortar Hilti HIT-MM Plus and a steel element. The steel element consists of a threaded rod HIT-V or a commercial threaded rod with washer and hexagon nut in the range of M8 to M16.

The steel element is placed into a drilled hole filled with injection mortar and is anchored via the bond between metal part, injection mortar and concrete.

The product description is given in Annex A.

2 Specification of the intended use in accordance with the applicable European Assessment Document

The performances given in Section 3 are only valid if the anchor is used in compliance with the specifications and conditions given in Annex B.

The verifications and assessment methods on which this European Technical Assessment is based lead to the assumption of a working life of the anchor of at least 50 years. The indications given on the working life cannot be interpreted as a guarantee given by the producer, but are to be regarded only as a means for choosing the right products in relation to the expected economically reasonable working life of the works.

3 Performance of the product and references to the methods used for its assessment

3.1 Mechanical resistance and stability (BWR 1)

Essential characteristic	Performance
Characteristic resistance under tension and shear loads	See Annex C 1
Displacements under tension and shear loads	See Annex C 2

3.2 Safety in case of fire (BWR 2)

Essential characteristic	Performance
Reaction to fire	Anchorage satisfy requirements for Class A1
Resistance to fire	No performance assessed

3.3 Hygiene, health and the environment (BWR 3)

Regarding dangerous substances there may be requirements (e.g. transposed European legislation and national laws, regulations and administrative provisions) applicable to the products falling within the scope of this European Technical Assessment. In order to meet the provisions of Regulation (EU) No 305/2011, these requirements need also to be complied with, when and where they apply.

3.4 Safety in use (BWR 4)

The essential characteristics regarding Safety in use are included under the Basic Works Requirement Mechanical resistance and stability.

4 Assessment and verification of constancy of performance (AVCP) system applied, with reference to its legal base

In accordance with guideline for European technical approval ETAG 001, April 2013, used as European Assessment Document (EAD) according to Article 66 Paragraph 3 of Regulation (EU) No 305/2011, the applicable European legal act is: [96/582/EC].

The system to be applied is: 1

5 Technical details necessary for the implementation of the AVCP system, as provided for in the applicable European Assessment Document

Technical details necessary for the implementation of the AVCP system are laid down in the control plan deposited at Deutsches Institut für Bautechnik.

Issued in Berlin on 3 April 2017 by Deutsches Institut für Bautechnik

Andreas Kummerow
p.p. Head of Department

beglaubigt:
Baderschneider

Installed condition

Figure A1:
Threaded rod and HIT-V...

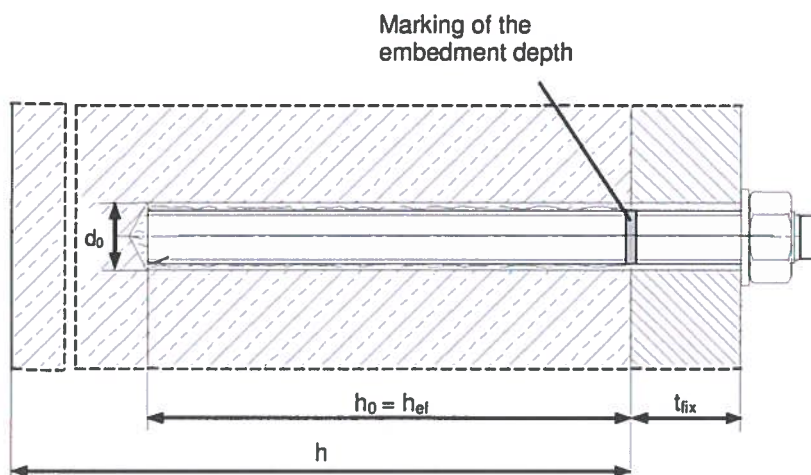

Injection system Hilti HIT-MM Plus

Product description
Installed condition

Annex A1

Product description: Injection mortar and steel elements

Injection mortar Hilti HIT-MM Plus: hybrid system with aggregate
330 ml and 500 ml

Marking:
HILTI HIT
Production number and
production line
Expiry date mm/yyyy

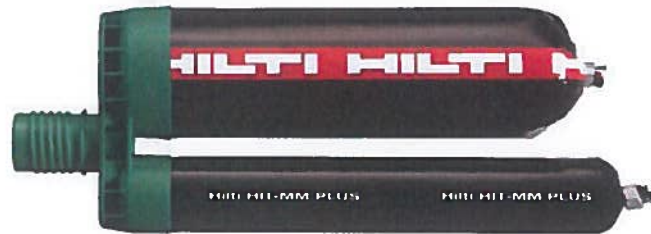

Product name: "Hilti HIT-MM Plus"

Static mixer Hilti HIT-RE-M



Steel elements

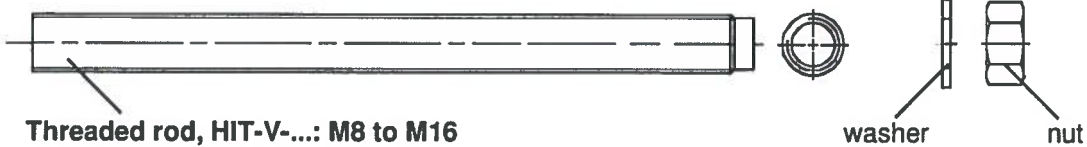

Threaded rod, HIT-V-...: M8 to M16

Commercial standard threaded rod with:

- Materials and mechanical properties according to Table A1
- Inspection certificate 3.1 according to EN 10204: 2004. The document shall be stored.
- Marking of embedment depth

Injection system Hilti HIT-MM Plus

Product description
Injection mortar / Static mixer / Steel elements

Annex A2

Table A1: Materials

Designation	Material
Metal parts made of zinc coated steel	
Threaded rod HIT-V-5.8(F)	Strength class 5.8, $f_{uk} = 500 \text{ N/mm}^2$; $f_{yk} = 400 \text{ N/mm}^2$ Elongation at fracture ($l_0=5d$) > 8% ductile Electroplated zinc coated $\geq 5 \mu\text{m}$ (F) Hot dip galvanized $\geq 45 \mu\text{m}$
Threaded rod HIT-V-8.8(F)	Strength class 8.8, $f_{uk} = 800 \text{ N/mm}^2$, $f_{yk} = 640 \text{ N/mm}^2$ Elongation at fracture ($l_0=5d$) > 12% ductile Electroplated zinc coated $\geq 5 \mu\text{m}$ (F) Hot dip galvanized $\geq 45 \mu\text{m}$
Washer	Electroplated zinc coated $\geq 5 \mu\text{m}$ Hot dip galvanized $\geq 45 \mu\text{m}$
Nut	Strength class of nut adapted to strength class of threaded rod Electroplated zinc coated $\geq 5 \mu\text{m}$ Hot dip galvanized $\geq 45 \mu\text{m}$
Metal parts made of stainless steel	
Threaded rod HIT-V-R	Strength class 70, $f_{uk} = 700 \text{ N/mm}^2$, $f_{yk} = 450 \text{ N/mm}^2$ Elongation at fracture ($l_0=5d$) > 8% ductile Stainless steel 1.4401, 1.4404, 1.4578, 1.4571, 1.4439, 1.4362 EN 10088-1:2014
Washer	Stainless steel 1.4401, 1.4404, 1.4578, 1.4571, 1.4439, 1.4362 EN 10088-1:2014
Nut	Strength class of nut adapted to strength class of threaded rod Stainless steel 1.4401, 1.4404, 1.4578, 1.4571, 1.4439, 1.4362 EN 10088-1:2014
Metal parts made of high corrosion resistant steel	
Threaded rod HIT-V-HCR	For $\leq \text{M20}$: $f_{uk} = 800 \text{ N/mm}^2$, $f_{yk} = 640 \text{ N/mm}^2$ Elongation at fracture ($l_0=5d$) > 8% ductile For $> \text{M20}$: $f_{uk} = 700 \text{ N/mm}^2$, $f_{yk} = 400 \text{ N/mm}^2$ Elongation at fracture ($l_0=5d$) > 8% ductile High corrosion resistant steel 1.4529, 1.4565 EN 10088-1:2014
Washer	High corrosion resistant steel 1.4529, 1.4565 EN 10088-1:2014
Nut	Strength class of nut adapted to strength class of threaded rod High corrosion resistant steel 1.4529, 1.4565 EN 10088-1:2014

Injection system Hilti HIT-MM Plus

Product description
Materials

Annex A3

Specifications of intended use



Anchorage subject to:

- Static and quasi static loading: M8 to M16

Base material:

- Reinforced or unreinforced normal weight concrete according to EN 206-1:2000.
- Strength classes C20/25 to C50/60 according to EN 206-1:2000.
- Non-cracked concrete according to Table B1.

Table B1: Specifications of intended use

Anchorage subject to:		HIT-MM Plus with ...	
Elements		Threaded rod, HIT-V-... 	
Hammer drilling mode 		✓	
Static and quasi static loading in non-cracked concrete		M8 to M16 Table : C1, C2, C3, C4	
Temperature in the base material at installation		-5° C to +40° C	
In-service temperature	Temperature range I:	-40 °C to +40 °C	(max. long term temperature +24 °C and max. short term temperature +40 °C)
	Temperature range II:	-40 °C to +80 °C	(max. long term temperature +50 °C and max. short term temperature +80 °C)

Use conditions (Environmental conditions):

- Structures subject to dry internal conditions (zinc coated steel, stainless steel or high corrosion resistant steel).
- Structures subject to external atmospheric exposure (including industrial and marine environment) and to permanently damp internal conditions, if no particular aggressive conditions exist (stainless steel or high corrosion resistant steel).
- Structures subject to external atmospheric exposure and to permanently damp internal conditions, if other particular aggressive conditions exist (high corrosion resistant steel).

Note: Particular aggressive conditions are e.g. permanent, alternating immersion in seawater or the splash zone of seawater, chloride atmosphere of indoor swimming pools or atmosphere with extreme chemical pollution (e.g. in desulphurization plants or road tunnels where de-icing products are used).

Injection system Hilti HIT-MM Plus

**Intended Use
Specifications**

Annex B1

Design:

- Anchorages are designed under the responsibility of an engineer experienced in anchorages and concrete work.
- Verifiable calculation notes and drawings are prepared taking account of the loads to be anchored. The position of the anchor is indicated on the design drawings (e. g. position of the anchor relative to reinforcement or to supports, etc.).
- Anchorages under static or quasi-static loading are designed in accordance with: "EOTA Technical Report TR 029, 09/2010" or "CEN/TS 1992-4:2009"

Installation:

- Use category: dry or wet concrete (not in flooded holes)
- Overhead installation is admissible
- Anchor installation carried out by appropriately qualified personnel and under the supervision of the person responsible for technical matters of the site.

Injection system Hilti HIT-MM Plus

**Intended Use
Specifications**

Annex B2

Table B2: Installation parameters of threaded rod, HIT-V-...

HIT-MM Plus with threaded rod, HIT-V-...		M8	M10	M12	M16
Diameter of element	$d^{1)} = d_{nom}^{2)}$ [mm]	8	10	12	16
Nominal diameter of drill bit	d_0 [mm]	10	12	14	18
Range of effective embedment depth and depth of drilled hole	$h_{ef} = h_0$ [mm]	60 to 96	60 to 120	70 to 144	80 to 192
Maximum diameter of clearance hole in the fixture ³⁾	d_f [mm]	9	12	14	18
Minimum thickness of concrete member	h_{min} [mm]	$h_{ef} + 30 \text{ mm}$ $\geq 100 \text{ mm}$			$h_{ef} + 2 \cdot d_0$
Maximum torque moment	T_{max} [Nm]	10	20	40	80
Minimum spacing	s_{min} [mm]	40	50	60	80
Minimum edge distance	c_{min} [mm]	40	50	60	80

1) Parameter for design according to "EOTA Technical Report TR 029".

2) Parameter for design according to "CEN/TS 1992-4:2009".

3) For larger clearance hole see TR 029, section 1.1.

HIT-V-...

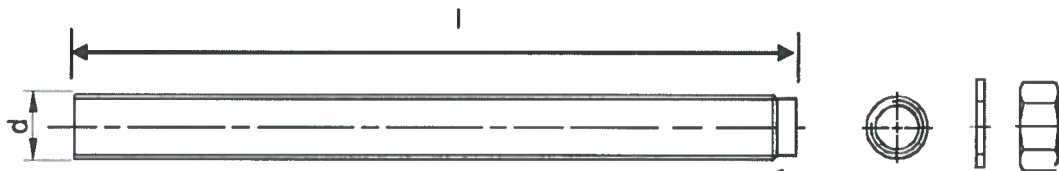

Marking:

5.8 - l = HIT-V-5.8 M...x l
 5.8F - l = HIT-V-5.8F M...x l
 8.8 - l = HIT-V-8.8 M...x l
 8.8F - l = HIT-V-8.8F M...x l
 R - l = HIT-V-R M...x l
 HCR - l = HIT-V-HCR M...x l

Injection system Hilti HIT-MM Plus

Intended Use
Installation parameters





Annex B3

Table B3: Maximum working time and minimum curing time ¹⁾

Temperature in the base material T	Maximum working time t_{work}	Maximum curing time t_{cure}
-5°C to 0°C	10 min	12 h
> 0°C to 5°C	10 min	5 h
> 5°C to 10°C	8 min	2,5 h
> 10°C to 20°C	5 min	1,5 h
> 20°C to 30°C	3 min	45 min
> 30°C to 40°C	2 min	30 min

¹⁾ The curing time data are valid for dry base material only.
In wet base material the curing times must be doubled.

Table B4: Parameters of cleaning and setting tools

Elements	Drill and clean		Installation
HIT-V-...	Hammer drilling	Brush	Piston plug
			
size	d_0 [mm]	HIT-RB	HIT-SZ
M8	10	10	-
M10	12	12	12
M12	14	14	14
M16	18	18	18

Cleaning alternatives

Manual Cleaning (MC):

Hilti hand pump for blowing out drill holes with diameters $d_0 \leq 18$ mm and drill hole depths $h_0 \leq 10 \cdot d$



Compressed air cleaning (CAC):

Air nozzle with an orifice opening of minimum 3,5 mm in diameter.



Injection system Hilti HIT-MM Plus

Intended Use

Minimum working and curing time
Cleaning and setting tools

Annex B4

Installation

Hole drilling

Hammer drilling

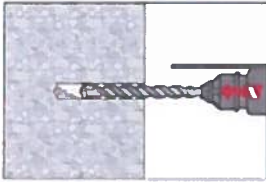

Drill hole to the required embedment depth with a hammer drill set in rotation-hammer mode using an appropriately sized carbide drill bit.

Drill hole cleaning

Just before setting an anchor, the drill hole must be free of dust and debris.
Inadequate hole cleaning = poor load values.

Manual Cleaning (MC) Non-cracked concrete only

for drill hole diameters $d_0 \leq 18$ mm and drill hole depths $h_0 \leq 10 \cdot d$

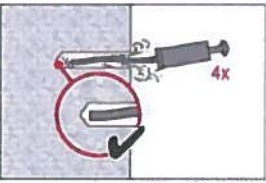

The Hilti manual pump may be used for blowing out drill holes up to diameters $d_0 \leq 18$ mm and embedment depths up to $h_{ef} \leq 10 \cdot d$.
Blow out at least 4 times from the back of the drill hole until return air stream is free of noticeable dust

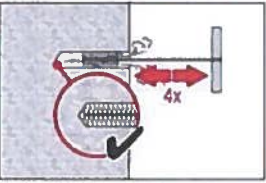

Brush 4 times with the specified brush (see Table B4) by inserting the steel brush Hilti HIT-RB to the back of the hole (if needed with extension) in a twisting motion and removing it.
The brush must produce natural resistance as it enters the drill hole (brush $\varnothing \geq$ drill hole \varnothing) - if not the brush is too small and must be replaced with the proper brush diameter.

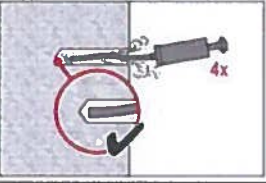

Blow out again with manual pump at least 4 times until return air stream is free of noticeable dust.

Compressed air cleaning (CAC) for all drill hole diameters d_0 and all drill hole depths h_0

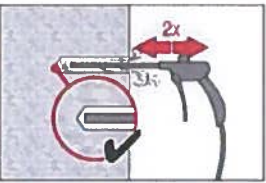

Blow 2 times from the back of the hole (if needed with nozzle extension) over the hole length with oil-free compressed air (min. 6 bar at $6 \text{ m}^3/\text{h}$) until return air stream is free of noticeable dust.

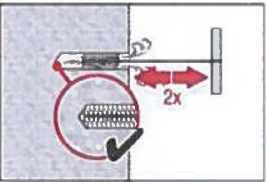

Brush 2 times with the specified brush (see Table B4) by inserting the steel brush Hilti HIT-RB to the back of the hole (if needed with extension) in a twisting motion and removing it.
The brush must produce natural resistance as it enters the drill hole (brush $\varnothing \geq$ drill hole \varnothing) - if not the brush is too small and must be replaced with the proper brush diameter.

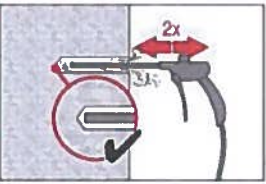

Blow again with compressed air 2 times until return air stream is free of noticeable dust.

Injection system Hilti HIT-MM Plus

Intended Use
Installation instructions

Annex B5





Injection preparation					
	<p>Tightly attach new Hilti mixing nozzle HIT-RE-M to foil pack manifold (snug fit). Do not modify the mixing nozzle.</p> <p>Observe the instruction for use of the dispenser.</p> <p>Check foil pack holder for proper function. Do not use damaged foil packs / holders.</p> <p>Insert foil pack into foil pack holder and put holder into HIT-dispenser.</p>				
	<p>Discard initial adhesive. The foil pack opens automatically as dispensing is initiated. Depending on the size of the foil pack an initial amount of adhesive has to be discarded. Discarded quantities are</p> <table border="0" style="margin-left: auto; margin-right: auto;"> <tr> <td style="padding-right: 20px;">2 strokes</td> <td>for 330 ml foil pack,</td> </tr> <tr> <td>3 strokes</td> <td>for 500 ml foil pack</td> </tr> </table>	2 strokes	for 330 ml foil pack,	3 strokes	for 500 ml foil pack
2 strokes	for 330 ml foil pack,				
3 strokes	for 500 ml foil pack				
Inject adhesive from the back of the drill hole without forming air voids.					
	<p>Inject the adhesive starting at the back of the hole, slowly withdrawing the mixer with each trigger pull.</p> <p>Fill holes approximately 2/3 full, or as required to ensure that the annular gap between the anchor and the concrete is completely filled with adhesive along the embedment length.</p>				
	<p>After injection is completed, depressurize the dispenser by pressing the release trigger. This will prevent further adhesive discharge from the mixer.</p>				
	<p>Overhead installation and/or installation with embedment depth $h_{ef} > 250\text{mm}$. For overhead installation the injection is only possible with the aid of extensions and piston plugs. Assemble HIT-RE-M mixer, extension(s) and appropriately sized piston plug HIT-SZ (see Table B4). Insert piston plug to back of the hole and inject adhesive. During injection the piston plug will be naturally extruded out of the drill hole by the adhesive pressure</p>				
Setting the element					
	<p>Before use, verify that the element is dry and free of oil and other contaminants. Mark and set element to the required embedment depth until working time t_{work} has elapsed. The working time t_{work} is given in Table B3</p>				
	<p>For overhead installation use piston plugs and fix embedded parts with e.g. wedges (HIT-OHW).</p>				
	<p>Loading the anchor: After required curing time t_{cure} (see Table B3) the anchor can be loaded.</p> <p>The applied installation torque shall not exceed the values T_{max} given in Table B2.</p>				
Injection system Hilti HIT-MM Plus					
Intended Use Installation instructions	Annex B6				

Table C1: Characteristic values of resistance for threaded rod, HIT-V-... under tension loads in concrete

HIT-MM Plus with threaded rod, HIT-V-...		M8	M10	M12	M16
Installation safety factor	$\gamma_2^{1)} = \gamma_{inst}^{2)}$ [-]	1,0			
Steel failure					
Characteristic steel resistance	$N_{Rk,s}$ [kN]	$A_s \cdot f_{uk}$			
Combined pullout and concrete cone failure					
Characteristic bond resistance in non-cracked concrete C20/25					
Temperature range I: 40 °C/24 °C	$\tau_{Rk,ucr}$ [N/mm ²]	7,5			
Temperature range II: 80 °C/50 °C	$\tau_{Rk,ucr}$ [N/mm ²]	5,5			
Factor acc. to section 6.2.2.3 of CEN/TS 1992-4:2009 part 5	$k_8 = k_{ucr}^{2)}$ [-]	10,1			
Increasing factors for τ_{Rk} in concrete	ψ_c	C30/37	1,04		
		C40/50	1,07		
		C50/60	1,09		
Splitting failure					
Edge distance $c_{cr,sp}$ [mm] for	$h / h_{ef} \geq 2,0$	$1,0 \cdot h_{ef}$			
	$2,0 > h / h_{ef} > 1,3$	$4,6 h_{ef} - 1,8 h$			
	$h / h_{ef} \leq 1,3$	$2,26 h_{ef}$			
Spacing	$s_{cr,sp}$ [mm]	$2 \cdot c_{cr,sp}$			

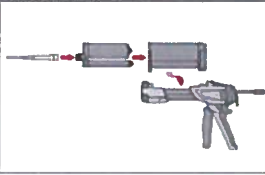
¹⁾ Parameter for design according to EOTA Technical Report TR 029.

²⁾ Parameter for design according to CEN/TS 1992-4:2009.

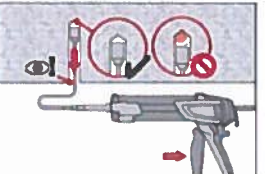
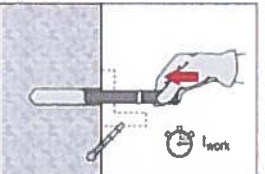
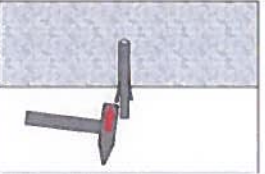
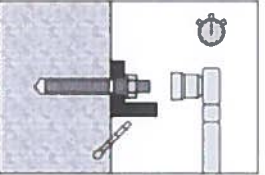
Table C2: Characteristic values of resistance for threaded rod, HIT-V-... under shear loads in concrete

HIT-MM Plus with threaded rod, HIT-V-...		M8	M10	M12	M16
Steel failure without lever arm					
Factor according to section 6.3.2.1 of CEN/TS 1992-4: 2009 part 5	$k_2^{2)}$ [-]	1,0			
Characteristic steel resistance	$V_{Rk,s}$ [kN]	$0,5 \cdot A_s \cdot f_{uk}$			
Steel failure with lever arm					
Characteristic bending moment	$M^0_{Rk,s}$ [Nm]	$1,2 \cdot W_{el} \cdot f_{uk}$			
Concrete pry-out failure					
Factor acc. to equation (5.7) of TR 029 or acc. to equation (27) of CEN/TS 1992-4: 2009 part 5	$k^1) = k_3^{2)}$ [-]	2,0			

¹⁾ Parameter for design according to EOTA Technical Report TR 029.

²⁾ Parameter for design according to CEN/TS 1992-4:2009.

Injection system Hilti HIT-MM Plus

Performances

Characteristic values of resistance under tension and shear loads in concrete
Design according to „EOTA Technical Report TR 029, 09/2010“or “CEN/TS 1992-4:2009”

Annex C1

Table C3: Displacement under tension load in mm/(N/mm²)

HIT-MM Plus with threaded rod, HIT-V-...			M8	M10	M12	M16
Displacement	δ_{N0}	[mm/(N/mm ²)]	0,07	0,07	0,07	0,08
Displacement	$\delta_{N\infty}$	[mm/(N/mm ²)]	0,07	0,07	0,07	0,08

Table C4: Displacement under shear load in mm/(N/mm²)

HIT-MM Plus with threaded rod, HIT-V-...			M8	M10	M12	M16
Displacement	δ_{V0}	[mm/(N/mm ²)]	0,06	0,06	0,05	0,04
Displacement	$\delta_{V\infty}$	[mm/(N/mm ²)]	0,09	0,08	0,08	0,06

Injection system Hilti HIT-MM Plus

Performances
Displacements

Annex C2